

High-Precision Shoulder Milling Cutter

Wavemill **WEZ** Series

Ultra-Refined "Universal" Cutter





General Features

Supports Various Machining Operations

A lineup of cutter sizes from Ø 14 to Ø 160 mm, which enable large ramping angles, 28 repeater type items are now available in addition to the modular type and short shank type.

Excellent Machining Quality

With a combination of optimised cutting edge shape and high-precision molding technology, superb wall surface accuracy and surface finish quality are achieved.

Excellent Sharpness with Low Resistance

Reducing machining noise and suppressing burrs, the lineup includes ground type inserts with a focus on sharpness.

Applicable to Various Work Materials

In addition to the general-purpose grade ACU2500, the new generation coated carbide grades XCU2500/XCK2000 are available. Applicable to various work materials such as steel, stainless steel, cast iron, exotic alloys and more.

Product Range WEZ (Standard)

Type	Cat. No.	Diameter Range (mm) / No of Teeth																	
		Ø14	Ø16	Ø18	Ø20	Ø22	Ø25	Ø26	Ø28	Ø30	Ø32	Ø35	Ø40	Ø50	Ø63	Ø80	Ø100	Ø125	Ø160
Shell	WEZ 11000RS											4, 6	5, 7	6, 8	7, 10	9, 12			
	WEZ 11000R (Inch)														7, 10	9, 12			
	WEZ 17000RS											3, 4	3, 5	4, 6	4, 7	5, 8	6, 9, 11	8, 10, 12	
	WEZ 17000R (Inch)														4, 7	5, 8	6, 9, 11	8, 10, 12	
Shank	WEZ 11000E	1	2*	2	2*, 3*	3	2, 3*, 4*		4	4	2, 3, 4, 5*	5	2, 4, 6	5, 7	8	10			
	WEZ 11000ES	1	2*		3*		4*												
	WEZ 11000EL	1	2*	2	2*	2	2*, 3		2	2	2*, 3	2, 3	2	3					
	WEZ 17000E						2*		2	3	2, 3*	3	3, 4	3*, 5*	4*, 6*	7			
	WEZ 17000ES						2				3								
	WEZ 17000EL						2		2	2	2*, 3	2	2, 3, 4	3*, 5*	4*, 6*				
Modu- lar	WEZ 11000M		2	2	2, 3	3	2, 3, 4	4, 5	4, 5	2, 4, 5	2, 3, 4, 5	2, 5	2, 4, 5, 6						
	WEZ 17000M						2, 3	2	2, 3	2, 3, 4	2, 3	2, 3, 4							

* Different shank diameters in stock

Product Range WEZR (Repeater)

Type	Cat. No.	Diameter Range (mm) / No of Teeth								
		Ø20	Ø25	Ø30	Ø32	Ø35	Ø40	Ø50	Ø63	Ø80
Shell	WEZR 11000RS						4	4		
	WEZR 17000RS							2, 3, 4	3, 4, 5	5
Shank	WEZR 11000E	1, 2	2	2	2, 3	3	3, 4			
	WEZR 17000E						2, 3	2, 3		
Modu- lar	WEZR 11000M				3					
	WEZR 17000M						3			

Suitable Applications

Supports Ramping, Helical Milling, Plunge Cutting

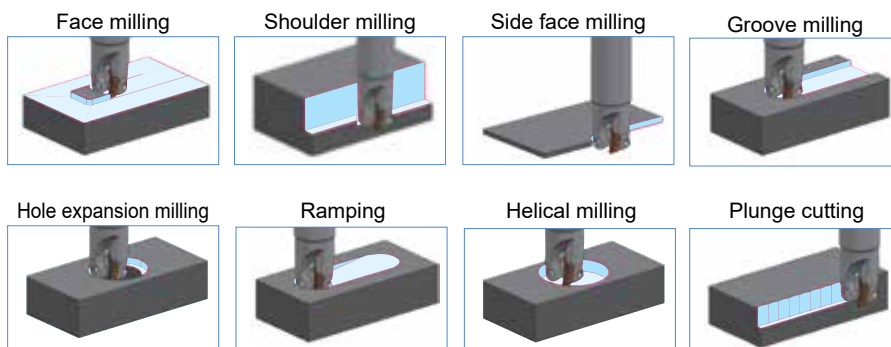

Optimised Body Design

Wide guide face for stable insert clamping.



WEZ11 type

Chipbreaker Lineup

Work Material	P		M	K	S	H	N
	L Type	G Type	H Type	F Type	P Type	S Type	
Chipbreaker							
AO_T11 Cutting edge geometrie							
AO_T17 Cutting edge geometrie							
Applications	Light cut, low rigidity machining	Main breaker for general purpose to interrupted machining	Heavy cut, heavy interrup- ted machining, hardened steel	Light cut, finishing, low-burr design	Light cut, high-precision machining, high surface wall quality		For non-ferrous metals

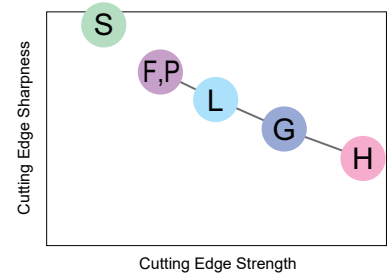

Product Range Inserts

Main Grade: ACU2500; S-Type: H20, DL2000

Cat. No.	Nose Radius (mm)													
	R0,2	R0,4	R0,5	R0,8	R1,0	R1,2	R1,6	R2,0	R2,4	R3,0	R3,2	R4,0	R5,0	R6,4
AOMT 11T3 PEER-G	●	●	●	●	●	●	●	●	●	●	●			
AOMT 11T3 PEER-H		●		●		●	●							
AOET 11T3 PEER-F	●	●	●	●	●	●	●	●	●	●	●			
AOET 11T3 PEER-P16	●	●	●	●	●	●	●	●	●	●	●			
AOET 11T3 PEER-P20	●	●	●	●	●	●	●	●	●	●	●			
AOET 11T3 PEER-P25	●	●	●	●	●	●	●	●	●	●	●			
AOET 11T3 PEFR-S	●	●	●	●	●	●	●	●	●	●	●			
AOMT 1705 PEER-L	●	●	●	●	●	●	●	●	●	●	●			
AOMT 1705 PEER-G	●	●	●	●	●	●	●	●	●	●	●	●	●	●
AOMT 1705 PEER-H		●		●		●	●							
AOET 1705 PEER-F	●	●	●	●	●	●	●	●	●	●	●	●	●	●
AOET 1705 PEER-P25	●	●	●	●	●	●	●	●	●	●	●	●	●	●
AOET 1705 PEER-P32	●	●	●	●	●	●	●	●	●	●	●	●	●	●
AOET 1705 PEFR-S	●	●	●	●	●	●	●	●	●	●	●	●	●	●

Improved Milling Quality

Excellent Squareness

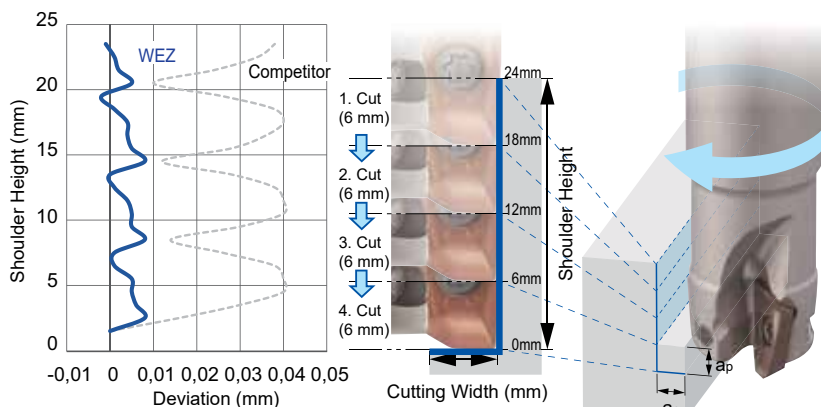

Machine: Vertical Machining Centre BT40,
 Work Material: C50
 Tool: WEZ 11020 E03 (Ø 20, 3 teeth)
 Insert: AOMT11T308PEER-G (ACU2500)
 Cutting Conditions: $v_c = 150$ m/min, $f_z = 0,15$ mm/t, $a_p = 6$ mm x 4 passes, $a_e = 5$ mm, dry

Excellent Surface Quality

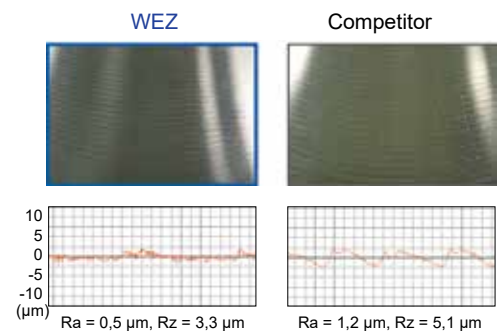

Lower cutting force helps reduce machining noise

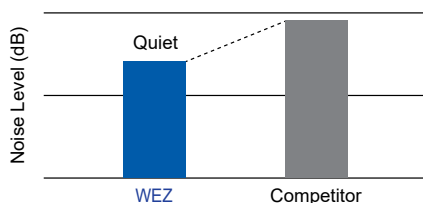

Machine: Vertical Machining Centre BT40,
 Work Material: C50
 Tool: WEZ 11020 E03 (Ø 20, 3 teeth)
 Insert: AOMT11T308PEER-G (ACU2500)
 Cutting Conditions: $v_c = 150$ m/min, $f_z = 0,15$ mm/t, $a_p = 8$ mm, $a_e = 5$ mm, dry



■ Features

Developed for Multi-tasking Machines

Short shank type ideal for low-rigidity multi-tasking machines.

Superb Machining Quality

Shank design ideal for ER collets with face contact design that increases rigidity, realizing excellent shoulder accuracy and finished surface quality.

A Wide Selection of Inserts

Supports various machining applications with a wide selection of chipbreakers, with sharp cutting edges, different nose radii and dedicated grades for specific work materials.

■ Cutting Performance

● Excellent Squareness

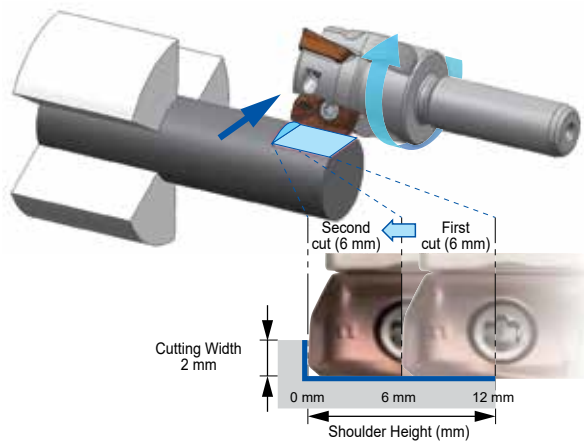

Machine:	Composite NC lathe
Work Material:	X5CrNiS1810, Ø 16 round bar
Tool:	WEZ11020ES03-10 (Ø 20, 3 flutes)
Insert:	AOET11T308PEER-F (ACU2500)
Cutting Data:	$v_c = 100$ m/min, $f_z = 0,08$ mm/t $a_p = 6$ mm x 2 passes, $a_e = 2$ mm, wet

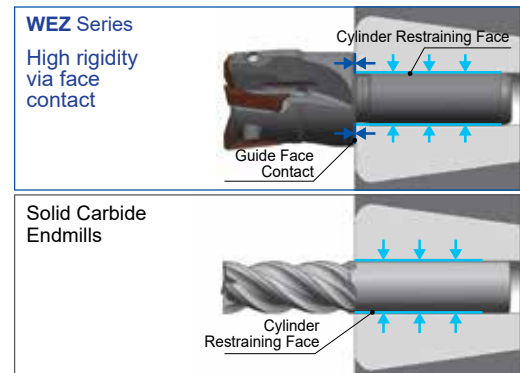

● Excellent Machined Surface Quality

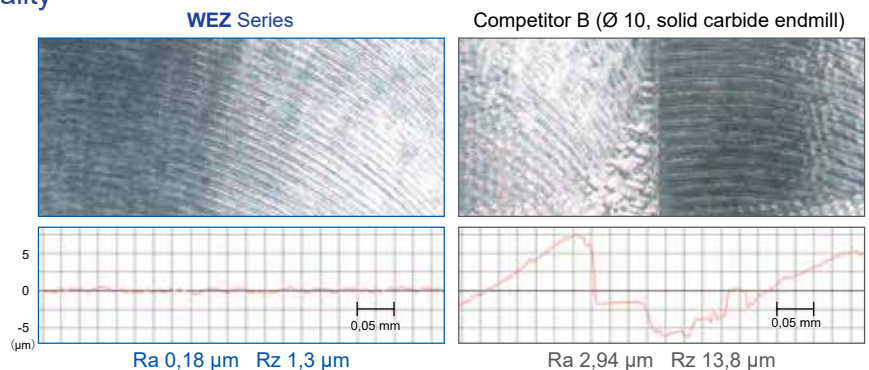
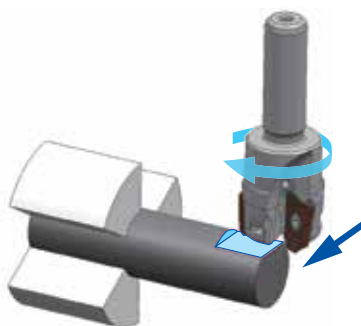

Machine:	Composite NC lathe
Work Material:	X5CrNiS1810, Ø 16 round bar
Tool:	WEZ11020ES03-10 (Ø 20, 3 flutes)
Insert:	AOET11T308PEER-F (ACU2500)
Cutting Data:	WEZ type: $v_c = 100$ m/min, $f_z = 0,05$ mm/t, $a_p = 2$ mm, $a_e = 12$ mm, wet Competitor: $v_c = 100$ m/min, $f_z = 0,05$ mm/t, $a_p = 2$ mm, $a_e = 6$ mm x 2 passes, wet (solid carbide endmill)

Larger tool diameter than carbide solid endmills enables reduced number of passes for high-efficiency machining.

Good shoulder accuracy and machined surface quality, eliminating the finishing process.

Shoulder Milling Tool Selection Guide

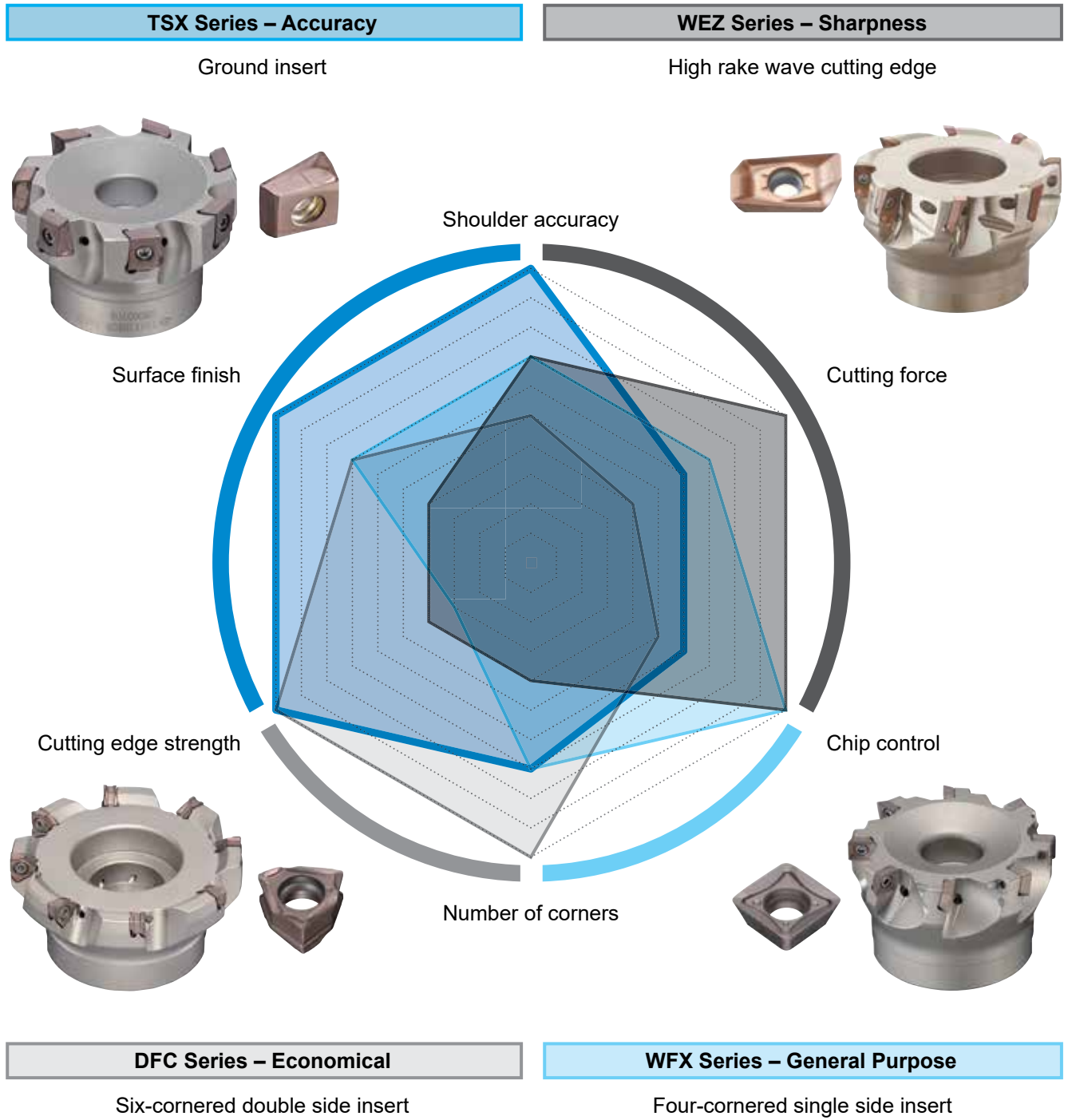

★★★ Top recommendation

	Surface Finish	Shoulder Accuracy	Cutting Force	Chip Control	Number of Corners	Cutting edge Strength
WEZ Series	★★★	★★★	★★★	★★★	★	★★☆
TSX Series	★★★	★★★	★★	★★☆	★★	★★★
DFC Series	★★☆	★	★	★★☆	★★★	★★★
WFX Series	★★☆	★★	★★	★★★	★★	★★

"WaveMill" Series

WEZ Type

High-precision Ground Class Insert with Excellent Sharpness

Ground Finish on Cutting Edge and Guide Face

The guide face has a ground finish as well as the cutting edge, minimizing corner difference when mounting on the body.

Stable runout precision and machining quality.

Cutting edge flank

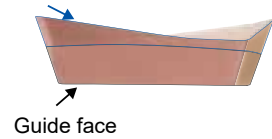

Guide face

Lineup of Chipbreakers for Ground Inserts

F Type

Cutting edge specialized for sharpness and machining accuracy



Sharpness from ground finish enables burr control.

Excellent squareness with all diameters.

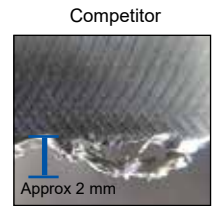
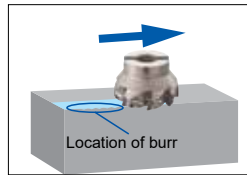

Machine: Vertical Machining Centre BT50,
 Work Material: X5CrNiS18 9
 Tool: WEZ 11050 RS07 (Ø 50, 7 teeth)
 Insert: AOET11T308PEER-F (ACU2500)
 Cutting Conditions: $v_c = 120$ m/min, $f_z = 0,12$ mm/t, $a_p = 1$ mm, $a_e = 30$ mm, dry

P Type

Chipbreaker for wall surface squareness equivalent to solid endmills



Premium item with cutting edge shape optimised for each cutter diameter while maintaining the F type chipbreaker's sharpness.

Enables wall surface squareness equal to solid endmills through a blade shape optimised for each tool diameter.

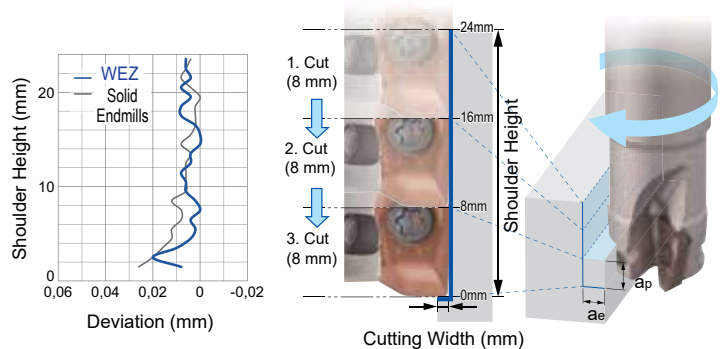

P Type Chipbreaker Selection

Cat. No.	Cutter Diameter (mm)										
	Ø14	Ø16	Ø18	Ø20	Ø22	Ø25	Ø28	Ø30	Ø32	Ø35	⇒ Ø40
AOET11T3__PEER-P__	-P16	-P20	-	-P25	-	-	-	-	-	-	-
AOET1705__PEER-P__	-	-	-	-	-	-P25	-	-P32	-	-	-

Machine: Vertical Machining Centre BT50,
 Work Material: C50
 Tool: WEZ 11020 E03 (Ø 20, 3 teeth)
 Insert: AOET11T308PEER-P20 (ACU2500)
 Cutting Conditions: $v_c = 150$ m/min, $f_z = 0,1$ mm/t, $a_p = 8$ mm x 3 passes, $a_e = 1$ mm, dry

S Type

Sharp edge chipbreaker for non-ferrous metals, with excellent adhesion resistance



Suppresses adhesion with rake face lapping.

DLC coat inserts available for further improved adhesion resistance.



Machine: Vertical Machining Centre BT50,
 Work Material: AlSi12Cu
 Tool: WEZ 11020 E03 (Ø 20, 3 teeth)
 Insert: AOET11T308PEER-S (H20)
 Cutting Conditions: $v_c = 350$ m/min, $f_z = 0,1$ mm/t, $a_p = 3$ mm, $a_e = 10$ mm, dry

Insert Grades Selection Guide

New generation coated carbide grades XCU2500/ XCK2000 now available. Enhanced lineup of coatings in addition to cemented carbide and cermet for milling steel, stainless steel, cast iron and aluminum alloy.

ISO	Finishing – Light Cutting	Medium Cutting	Rough – Heavy Cutting
P	Coated Carbide		
	ACP2000	ACU2500 XCU2500	ACP3000
	Cermet		
	T2500A		
M	Coated Carbide		
	ACM200	ACU2500 XCU2500	ACM300
K	Coated Carbide		
		ACU2500 XCU2500	
		XCK2000	
		ACK2000	ACK3000
N	Coated Carbide		
	DL2000		
	Carbide		
		H20	

▽: CVD ▲: PVD

Coating Features

New Absotech™ (absolute technology) coating technology that realises absolute stability.

ABSOTECH CVD

Special Surface Treatment
Suppresses thermal cracking by introducing high compressive stress, resulting in chipping resistance more than twice as good as conventional types

Crystal Orientation Control Al₂O₃
By controlling the growth direction, Al₂O₃ is reinforced for crater wear resistance more than twice as good as conventional types

High Hardness TiCN
Increased TiCN hardness by using a C-rich composition for flank wear resistance more than twice as good as conventional types.

Grades: ACP2000, ACK2000

ABSOTECH PVD

New Super Multi-Layered Composition
Higher hardness and twice the conventional wear resistance due to a fine crystal structure AlTiCrBN-based nano-layered coating.

High Adhesion Strength
Significantly improved coating adhesion. Chipping resistance more than twice as good as conventional types.

Grades: ACU2500, ACP3000, ACK3000

ABSOTECH X CVD

Pure cubic crystal AlTiN with high Al content
With proprietary structural control technology, differently composed layers of AlTiN are stacked at the nanometre level. With a high Al-composition containing over 80% Al on average, it also maintains a cubic crystalline structure to achieve excellent thermal resistance and high hardness. Vastly improved wear resistance.

Special Surface Treatment
Proprietary surface treatment introduces high compression stress to the coating, suppressing the development of cracks.
Greatly improved fracture and thermal crack resistance.

Grades: XCU2500, XCK2000

Grade Characteristic Values

CVD

ISO	Grade	Hardness (HRA)	TRS (GPa)	Coating Type	Coating Thickness (µm)	Features	Old Grade
P	ACP2000	89,5	3,2	ABSOTECH	10	· For high-speed machining of steel · Stable long tool life in high-speed machining is realised by adopting a tough carbide substrate and a new coating with excellent thermal crack resistance	ACP100
	XCU2500	89,5	3,2	ABSOTECH X	6	· General-purpose grade for a wide variety of materials such as steel, cast iron and stainless steel · New coating combining wear and fracture resistance realises long tool life in medium-speed to high-speed machining	—
M	ACM200	89,8	3,4	Super FF Coat	6	· For machining high-hardness stainless steel · Adopts newly developed high-strength cemented carbide substrate with excellent wear resistance and thermal resistance, realizing outstanding stability when machining hardened stainless steel	AC230
K	ACK2000	91,7	3,1	ABSOTECH	10	· For high-speed cast iron milling · Stable long tool life in high-speed machining is realised by adopting a tough carbide substrate and a new coating with excellent thermal resistance	ACK100 ACK200
	XCK2000	91,7	2,5	ABSOTECH X	6	· For high-speed cast iron milling · Along with a high-hardness carbide substrate, the new coating combining wear and fracture resistance realises superb long tool life in medium-speed to high-speed machining	—

PVD

ISO	Grade	Hardness (HRA)	TRS (GPa)	Coating Type	Coating Thickness (µm)	Features	Old Grade
P	ACU2500	91,6	3,8	ABSOTECH	3	· General-purpose grade supporting steel, stainless steel, and cast iron machining · Adopts a carbide substrate with excellent fracture resistance and wear resistance, plus a new coating with excellent wear resistance and chipping resistance, realising stable long tool life with various work material grades	—
	ACP3000	89,5	3,2	ABSOTECH	3	· Our 1st recommended grade for milling steel · Carbide substrate with excellent thermal crack resistance, plus a new coating with excellent wear resistance and chipping resistance, realises stable long tool life over a wide range of cutting conditions	ACP200 ACP300
M	ACM300	89,8	3,4	(New) Super ZX Coat	3	· Our 1st recommended grade for milling stainless steel · Adopts high-strength cemented carbide substrate and super multi-layered coating for next-level wear resistance and fracture resistance	—
K	ACK3000	91,7	3,1	ABSOTECH	3	· Our 1st recommended grade for milling cast iron · Adopts a high thermal conductivity carbide substrate and a new coating with excellent wear resistance and chipping resistance, realizing stable long tool life over a wide range of cast iron machining operations	ACK300
N	DL2000	91,6	3,8	AURORA Coat (DLC)	0,5	· Grade for milling non-ferrous metal, utilising DLC coat with a low coefficient of friction and excellent adhesion resistance	—

Cermet

ISO	Grade	Hardness (HRA)	TRS (GPa)	Coating Type	Coating Thickness (µm)	Features	Old Grade
P M	T2500A	91,8	2,4	—	—	· For finishing of steel and stainless steel · Fine, uniform grain structure greatly improves toughness, realising long tool life and excellent surface finishes	T250A

Recommended Cutting Conditions

WEZ11 Type

Cutter: WEZ 11020 E03
 Insert: AO_T11T3 type
 Cutting Data: $a_p = 3 \text{ mm}$, $a_e = 10 \text{ mm}$, dry

Min. - Optimum - Max.

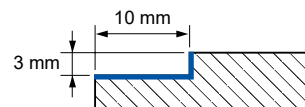

ISO	Material	HB	Chipbreaker	Grade										
				ACU2500	XCU2500	ACP2000	ACP3000	T2500A	XCK2000	ACK2000	ACK3000	ACM200	ACM300	DL2000
				Feed Rate (mm/tooth)										
				0,08-0,15-0,20	0,08-0,15-0,20	0,08-0,15-0,20	0,08-0,15-0,20	0,08-0,15-0,18	0,08-0,15-0,20	0,08-0,15-0,20	0,08-0,15-0,20	0,08-0,15-0,20	0,08-0,15-0,20	0,05-0,10-0,15
				Cutting Speed v_c (m/min)										
P	Unalloyed steel, <0,15%C, annealed	125	G	270-320-370	300-350-400	300-350-400	250-300-350	230-280-330						
	- , <0,45%C, annealed	190	G	170-220-270	200-250-300	200-250-300	150-200-250	130-180-230						
	- , <0,45%C, tempered	250	G	140-180-220	160-200-245	160-200-245	120-160-200	105-145-185						
	- , <0,75%C, annealed	270	G	110-145-175	130-165-195	130-165-195	100-130-165	85-115-150						
	- , <0,75%C, tempered	300	G	70-90-110	80-100-120	80-100-120	60-80-100	50-70-90						
	Low alloyed steel, annealed	180	G	160-205-255	190-235-280	190-235-280	140-190-235	120-170-215						
	- , tempered	275	G	90-120-150	110-135-165	110-135-165	80-110-140	70-100-125						
	- , tempered	300	G	85-110-130	100-125-150	100-125-150	75-100-125	65-90-115						
- , tempered	350	G	60-80-100	70-90-110	70-90-110	50-70-90	45-65-85							
M	High alloyed and tool steel, annealed	200	G	140-180-220	160-200-245	160-200-245	120-160-205							
	- , tempered	325	G	55-70-85	60-80-100	60-80-100	50-65-80							
	Stainless steel, ferritic/martensitic, annealed	200	G	110-140-170	160-190-210					140-170-190	90-110-140			
- , martensitic, tempered	240	G	100-125-150	145-170-190					125-150-170	80-100-125				
- , austenitic, plunged	180	G	120-150-180	170-200-220					150-180-200	100-120-150				
K	Grey cast iron		G	150-200-250	250-300-350			250-300-350	250-300-350	170-220-270				
	Nodular cast iron		G	90-120-150	150-180-210			150-180-210	150-180-210	100-130-160				
S	High tempered resist. alloys, Fe based, annealed		G	30-40-55							35-45-60	25-35-50		
	- , hardened		G	60-80-100							70-90-110	50-70-90		
N	Aluminium alloy, Si < 12,6%		S											500-750-100
	- , Si > 12,6%		S											170-200-250
	Copper alloy		S											300-330-350

The above recommended cutting conditions are meant as a guide. Actual conditions will depend on the individual machine, work shape and clamping. They will need to be adjusted according to machine rigidity, work clamp rigidity, cutting depth and other factors.

For groove milling, reduce the feed rate approximately 70 % of the corresponding value shown above.

WEZ17 Type

Cutter: WEZ 17032 E03
 Insert: AO_T1705 type
 Cutting Data: $a_p = 5 \text{ mm}$, $a_e = 16 \text{ mm}$, dry

Min. - Optimum - Max.

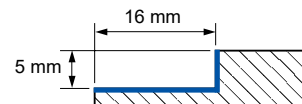

ISO	Material	HB	Chipbreaker	Grade										
				ACU2500	XCU2500	ACP2000	ACP3000	T2500A	XCK2000	ACK2000	ACK3000	ACM200	ACM300	DL2000
				Feed Rate (mm/tooth)										
				0,10-0,20-0,28	0,10-0,20-0,28	0,10-0,20-0,28	0,10-0,20-0,28	0,10-0,15-0,22	0,10-0,20-0,28	0,10-0,20-0,28	0,10-0,20-0,28	0,10-0,20-0,28	0,10-0,20-0,28	0,05-0,10-0,15
				Cutting Speed v_c (m/min)										
P	Unalloyed steel, <0,15%C, annealed	125	G	285-335-390	315-360-420	315-360-420	265-315-370	240-295-345						
	- , <0,45%C, annealed	190	G	180-230-285	210-265-315	210-265-315	160-210-265	135-190-240						
	- , <0,45%C, tempered	250	G	145-190-230	170-210-255	170-210-255	130-170-215	110-155-195						
	- , <0,75%C, annealed	270	G	115-150-185	135-170-205	135-170-205	100-135-170	90-125-155						
	- , <0,75%C, tempered	300	G	70-90-115	85-105-125	85-105-125	65-85-105	55-75-95						
	Low alloyed steel, annealed	180	G	170-220-265	200-245-295	200-245-295	150-200-250	130-180-225						
	- , tempered	275	G	100-130-155	115-145-175	115-145-175	85-115-145	75-105-135						
	- , tempered	300	G	90-115-140	105-130-155	105-130-155	75-105-130	65-90-120						
- , tempered	350	G	65-85-100	75-95-115	75-95-115	55-75-95	50-70-85							
M	High alloyed and tool steel, annealed	200	G	145-185-230	170-215-255	170-215-255	130-170-215							
	- , tempered	325	G	55-75-90	65-85-100	65-85-100	50-65-85							
	Stainless steel, ferritic/martensitic, annealed	200	G	115-145-175	165-195-215					145-175-195	100-115-145			
- , martensitic, tempered	240	G	105-130-155	150-175-195					130-155-175	85-105-130				
- , austenitic, plunged	180	G	125-155-190	180-210-230					160-190-210	105-125-160				
K	Grey cast iron		G	160-210-265	265-315-370			265-315-370	265-315-370	180-230-285				
	Nodular cast iron		G	95-125-160	160-190-220			160-190-220	160-190-220	105-140-170				
S	High tempered resist. alloys, Fe based, annealed		G	30-40-60							35-45-60	25-35-50		
	- , hardened		G	60-85-105							75-95-115	50-75-95		
N	Aluminium alloy, Si < 12,6%		S											500-750-100
	- , Si > 12,6%		S											170-200-250
	Copper alloy		S											300-330-350

The above recommended cutting conditions are meant as a guide. Actual conditions will depend on the individual machine, work shape and clamping. They will need to be adjusted according to machine rigidity, work clamp rigidity, cutting depth and other factors.

For groove milling, reduce the feed rate approximately 70 % of the corresponding value shown above.

Ramping / Helical Milling Upper Limits

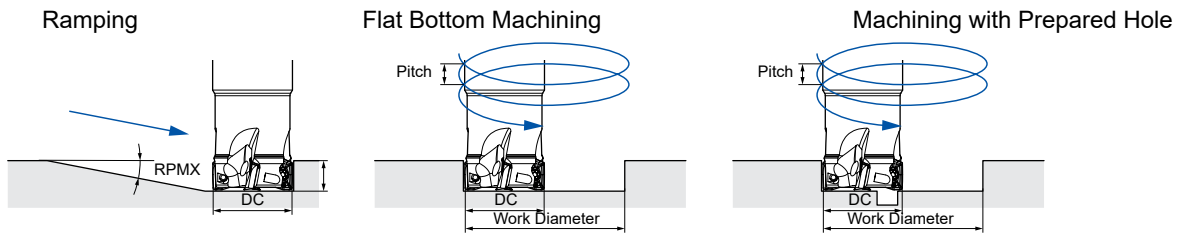

WEZ11 Type

DC Ø (mm)	Max.Ramping Angle	Flat Bottom Machining				Machining with Prepared Hole	
	RPMX (°)	Max. Machining Diam. (mm)	Max. Pitch (mm/rev)	Min. Machining Diam. (mm)	Max. Pitch (mm/rev)	Min. Machining Diam. (mm)	Max. Pitch (mm/rev)
14	13,2	25,3	8,4	23,1	5,9	19,0	1,9
16	10,5	29,3	7,6	27,0	5,6	21,7	1,5
18	8,1	33,3	6,7	30,9	5,0	25,2	1,4
20	6,5	37,3	6,0	34,9	4,6	29,1	1,3
22	5,3	41,3	5,4	38,8	4,3	32,9	1,3
25	4,1	47,3	4,8	44,8	3,9	38,9	1,3
28	3,4	53,3	4,4	50,7	3,6	44,9	1,3
30	3,0	57,3	4,2	54,7	3,5	48,8	1,3
32	2,7	61,3	4,0	58,7	3,3	52,8	1,2
35	2,3	67,3	3,8	64,6	3,1	58,8	1,2
40	1,8	77,3	3,4	74,6	2,9	68,8	1,2
50	1,2	97,3	3,0	94,6	2,6	88,8	1,1
63	0,8	123,3	2,8	120,5	2,5	114,7	1,1

WEZ17 Type

DC Ø (mm)	Max.Ramping Angle	Flat Bottom Machining				Machining with Prepared Hole	
	RPMX (°)	Max. Machining Diam. (mm)	Max. Pitch (mm/rev)	Min. Machining Diam. (mm)	Max. Pitch (mm/rev)	Min. Machining Diam. (mm)	Max. Pitch (mm/rev)
25	10,8	47,3	13,0	41,0	8,3	33,1	1,8
28	8,1	53,3	11,1	46,9	7,5	39,0	1,8
30	7,0	57,3	10,2	50,9	7,0	43,0	1,8
32	6,1	61,3	9,5	54,9	6,7	47,0	1,7
35	5,1	67,3	8,7	60,8	6,2	53,0	1,7
40	4,0	77,3	7,7	70,8	5,7	63,0	1,7
50	2,5	97,3	6,5	90,7	5,0	83,0	1,6
63	1,8	123,3	5,6	116,7	4,5	109,0	1,6

* The table above shows values with nose radius 0,8 mm

Plunge Cutting - Upper Limit for Radial Width a_e

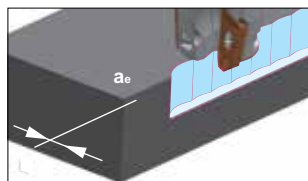

Type	Max. a_e (mm)
WEZ11	3
WEZ17	5

Precautions for Mounting

- (1) Clean the mounting seat and contact parts.
- (2) Apply screw lubrication to the screw thread as well as the screw head face to prevent seizure.
- (3) While pressing the insert solidly against the seat surface, tighten at the screws with the included wrench.
- (4) After tightening, check that there are no gaps between the surfaces.



"WaveMill" Series WEZ 11000 R(S)

Rake Angle	Radial	-7° - -11°	10 mm	90°
	Axial	14° - 15°		

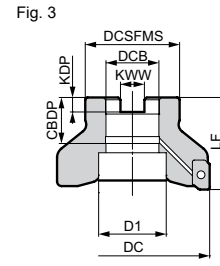
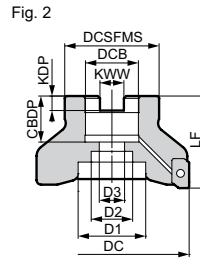
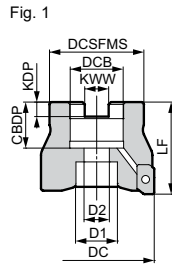

Body - WEZ (Shell Type)

Dimensions (mm)

Cat. No.	Stock	DC	DCSFMS	LF	DCB	KWW	KDP	CBDFP	D1	D2	D3	No. of Teeth	Weight (kg)	Fig.	
Metric	WEZ 11040RS04	●	40	33	40	16	8,4	5,6	18	14	9	-	4	0,21	1
	11040RS06	●	40	33	40	16	8,4	5,6	18	14	9	-	6	0,20	1
	11050RS05	●	50	41	40	22	10,4	6,3	20	18	11	-	5	0,32	1
	11050RS07	●	50	41	40	22	10,4	6,3	20	18	11	-	7	0,31	1
	11063RS06	●	63	50	40	22	10,4	6,3	20	18	11	-	6	0,58	1
	11063RS08	●	63	50	40	22	10,4	6,3	20	18	11	-	8	0,57	1
	11080RS07	●	*80	55	50	27	12,4	7,0	22	20	14	-	7	1,08	1
	11080RS10	●	*80	55	50	27	12,4	7,0	22	20	14	-	10	1,07	1
	11100RS09	●	100	70	50	32	14,4	8,0	32	46	-	-	9	1,57	3
11100RS12	●	100	70	50	32	14,4	8,0	32	46	-	-	12	1,56	3	
Inch	WEZ 11080R07	○	*80	55	50	25,4	9,5	6,0	25	20	14	-	7	1,09	1
	11080R10	○	*80	55	50	25,4	9,5	6,0	25	20	14	-	10	1,08	1
	11100R09	○	*100	70	63	31,75	12,7	8,0	32	46	27	18	9	2,12	2
	11100R12	○	*100	70	63	31,75	12,7	8,0	32	46	27	18	12	2,10	2

Inserts are sold separately. Check the arbor mounting size (DCB) when selecting the cutter.

* For securing the Ø 80 mm and Ø 100 mm cutter to the arbors, use JIS B1176 hexagonal bolt.
(Ø 80 mm: M12x30 to 35 mm, Ø 100 mm: M16x40x45 mm)

Spare Parts

Applicable Cutters	Insert Screw		Wrench
WEZ 11040RS04 11040RS06 11050RS05 11050RS07 11063RS06 11063RS08 11080R(S)07 11080R(S)10 11100R(S)09 11100R(S)12	BFTX0306IP	1,5	TRDR08IP

Recommended Cutting Conditions

→ P. 8

Identification Details

WEZ	11	050	R	S	07
Cutter Series	Insert Size	Cutter Diameter	Feed Direction	Metric	Number of Teeth

*When mounting inserts with nose radius of $\geq 2,4$ mm, modification of the body is required.



Modify this edge.

Reworking guidelines

Corner radius = 2,4 mm: C = 1 mm (AOMT11T324PEER)

Corner radius = 3,0 mm: C = 1 mm (AOMT11T330PEER)

Corner radius = 3,2 mm: C = 1 mm (AOMT11T332PEER)

Standard: R = 1 mm

C: Chamfer

R: Radius

Inserts

Precautions for Mounting → P. 9

Application	Coated Carbide								Carbide	DLC	Cermet	Dimensions (mm)		
High Speed / Light Cut														
General Purpose														
Roughing														
Cat. No.	ACU2500	XCU2500	ACP2000	ACP3000	XCK2000	ACK2000	ACK3000	ACM200	ACM300	H20	DL2000	T2500A	RE	Fig.
AOMT 11T302PEER-G	●		□	●		□	●	●	●	-	-	●	0,2	1
11T304PEER-G	●	○	●	●	○	●	●	●	●	-	-	●	0,4	1
11T305PEER-G	●		●	□		□	●	●	●	-	-	●	0,5	1
11T308PEER-G	●	○	●	●	○	●	●	●	●	-	-	●	0,8	1
11T310PEER-G	●		□	□		□	●	●	●	-	-	□	1,0	1
11T312PEER-G	●		□	●		□	●	●	●	-	-	□	1,2	1
11T316PEER-G	●		□	●		□	●	●	●	-	-		1,6	1
11T320PEER-G	●		□	●		□	●	●	●	-	-		2,0	1
11T324PEER-G	●		□	□		□	●	●	●	-	-		2,4	1
11T330PEER-G	●		□	●		□	●	●	●	-	-		3,0	2
11T332PEER-G	●		□	□		□	●	●	●	-	-		3,2	2
AOMT 11T304PEER-H	●	○	●	●	○	●	●	●	●	-	-	-	0,4	1
11T308PEER-H	●	○	●	●	○	●	●	●	●	-	-	-	0,8	1
11T312PEER-H	●		□	□		□	□	●	●	-	-	-	1,2	1
11T316PEER-H	●		□	□		□	□	●	●	-	-	-	1,6	1
AOET 11T302PEER-F	●		-			-				-	-	-	0,2	1
11T304PEER-F	●		-			-				-	-	-	0,4	1
11T305PEER-F	●		-			-				-	-	-	0,5	1
11T308PEER-F	●		-			-				-	-	-	0,8	1
11T310PEER-F	●		-			-				-	-	-	1,0	1
11T312PEER-F	●		-			-				-	-	-	1,2	1
11T316PEER-F	●		-			-				-	-	-	1,6	1
11T320PEER-F	●		-			-				-	-	-	2,0	1
11T324PEER-F	●		-			-				-	-	-	2,4	1
11T330PEER-F	●		-			-				-	-	-	3,0	2
11T332PEER-F	●		-			-				-	-	-	3,2	2
AOET 11T302PEFR-S	-	-	-	-	-	-	-	-	●	●	-	-	0,2	1
11T304PEFR-S	-	-	-	-	-	-	-	-	●	●	-	-	0,4	1
11T305PEFR-S	-	-	-	-	-	-	-	-	●	●	-	-	0,5	1
11T308PEFR-S	-	-	-	-	-	-	-	-	●	●	-	-	0,8	1
11T310PEFR-S	-	-	-	-	-	-	-	-	●	●	-	-	1,0	1
11T312PEFR-S	-	-	-	-	-	-	-	-	●	●	-	-	1,2	1
11T316PEFR-S	-	-	-	-	-	-	-	-	●	●	-	-	1,6	1
11T320PEFR-S	-	-	-	-	-	-	-	-	●	●	-	-	2,0	1
11T324PEFR-S	-	-	-	-	-	-	-	-	●	●	-	-	2,4	1
11T330PEFR-S	-	-	-	-	-	-	-	-	●	●	-	-	3,0	2
11T332PEFR-S	-	-	-	-	-	-	-	-	●	●	-	-	3,2	2

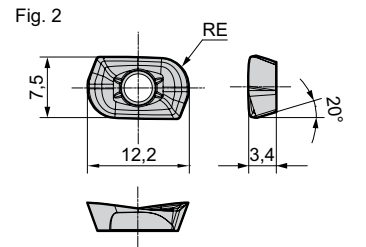
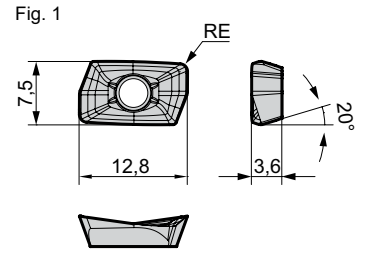

L: Low cutting force
 G: General purpose
 H: Strong edge
 F: Finishing
 P: High-precision machining
 S: Non ferrous metals

"Wave Mill" Series WEZ 17000 R(S)

Rake Angle	Radial	-4° - -9°	15 mm	90°
	Axial	10° - 15°		

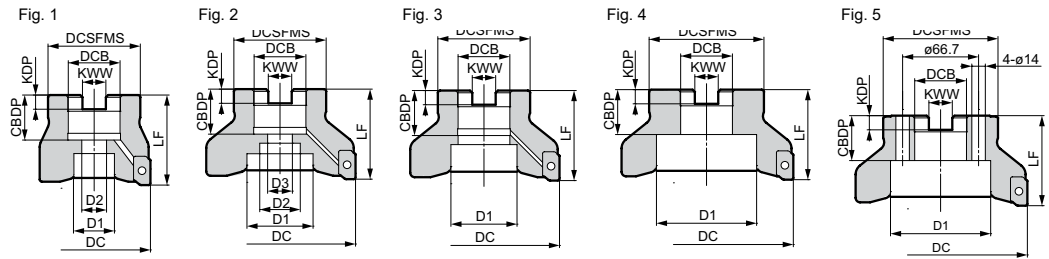

Body - WEZ (Shell Type)

Dimensions (mm)

Cat. No.	Stock	DC	DCSFMS	LF	DCB	KWW	KDP	CBDP	D1	D2	D3	No. of Teeth	Weight (kg)	Fig.	
Metric	WEZ 17040RS03	●	40	33	40	16	8,4	5,6	18	14	9	3	0,19	1	
	17040RS04	●	40	33	40	16	8,4	5,6	18	14	9	4	0,16	1	
	17050RS03	●	50	41	40	22	10,4	6,3	20	18	11	3	0,30	1	
	17050RS05	●	50	41	40	22	10,4	6,3	20	18	11	5	0,26	1	
	17063RS04	●	63	50	40	22	10,4	6,3	20	18	11	4	0,54	1	
	17063RS06	●	63	50	40	22	10,4	6,3	20	18	11	6	0,51	1	
	17080RS04	●	*80	55	50	27	12,4	7,0	22	20	14	4	1,10	1	
	17080RS07	●	*80	55	50	27	12,4	7,0	22	20	14	7	1,05	1	
	17100RS05	●	100	70	50	32	14,4	8,0	32	46	-	5	1,58	3	
	17100RS08	●	100	70	50	32	14,4	8,0	32	46	-	8	1,57	3	
	17125RS06	●	125	80	63	40	16,4	9,0	29	52	29	6	3,04	1	
	17125RS09	●	125	80	63	40	16,4	9,0	29	52	29	9	3,07	1	
	17125RS11	●	125	80	63	40	16,4	9,0	29	52	29	11	3,02	1	
17160RS08	●	160	130	63	40	16,4	9,0	29	90	-	8	5,24	5		
17160RS10	●	160	130	63	40	16,4	9,0	29	90	-	10	5,31	5		
17160RS12	●	160	130	63	40	16,4	9,0	29	90	-	12	5,26	5		
Inch	WEZ 17080R04	○	*80	55	50	25,4	9,5	6,0	25	20	14	4	1,10	1	
	17080R07	○	*80	55	50	25,4	9,5	6,0	25	20	14	7	1,06	1	
	17100R05	○	*100	70	63	31,75	12,7	8,0	32	46	27	18	5	2,08	2
	17100R08	○	*100	70	63	31,75	12,7	8,0	32	46	27	18	8	2,07	2
	17125R06	○	125	80	63	38,1	15,9	10,0	35,5	55	30	6	3,09	1	
	17125R09	○	125	80	63	38,1	15,9	10,0	35,5	55	30	9	3,11	1	
	17125R11	○	125	80	63	38,1	15,9	10,0	35,5	55	30	11	3,06	1	
	17160R08	○	160	100	63	50,8	19,1	11,0	38	72	-	8	5,04	4	
	17160R10	○	160	100	63	50,8	19,1	11,0	38	72	-	10	5,09	4	
	17160R12	○	160	100	63	50,8	19,1	11,0	38	72	-	12	5,04	4	

Inserts are sold separately. Check the arbor mounting size (DCB) when selecting the cutter.

* For securing the Ø 80 mm and Ø 100 mm cutter to the arbors, use JIS B1176 hexagonal bolt.
(Ø 80 mm: M12x30 to 35 mm, Ø 100 mm: M16x40x45 mm)

Spare Parts

Applicable Cutters	Insert Screw		Wrench	Handle Grip	Wrench Bit
	WEZ 17040RS03 17040RS04 17050RS03 17050RS05 17063RS04 17063RS06 17080R(S)04 17080R(S)07 17100R(S)05 17100R(S)08 17125R(S)06 17125R(S)09 17125R(S)11 17160R(S)08 17160R(S)10 17160R(S)12	BFTX0409IP	3,0	-	HPS1015
			TRDR15IP	-	-

Recommended Cutting Conditions

→ P. 8

● = Euro stock
○ = Japan stock

Identification Details

WEZ	17	100	R	S	05
Cutter Series	Insert Size	Cutter Diameter	Feed Direction	Metric	Number of Teeth

*When mounting inserts with nose radius of $\geq 2,4$ mm, modification of the body is required.

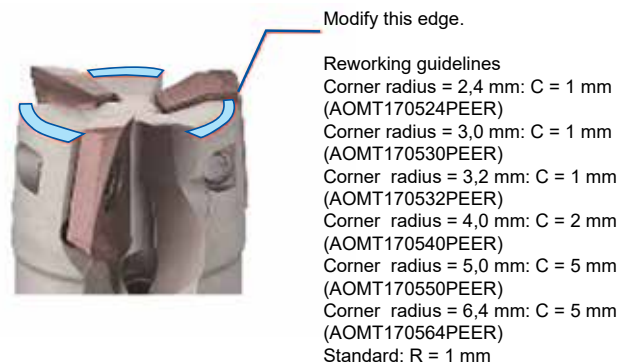

C: Chamfer
R: Radius

Inserts

Precautions for Mounting → P. 9

Application	Coated Carbide								Carbide	DLC	Cermet	Dimensions (mm)		
High Speed / Light Cut		P	P		K	K		M		N	P			
General Purpose	K	K		P	K		K	M	M	N	N			
Roughing	K			P			K	M	M					
Cat. No.	ACU2500	XCU2500	ACP2000	ACP3000	XCK2000	ACK2000	ACK3000	ACM200	ACM300	H20	DL2000	T2500A	RE	Fig.
AOMT 170502PEER-L	●		-	□		-	□	●	●	-	-	□	0,2	1
170504PEER-L	●	○	-	●	○	-	●	●	●	-	-	●	0,4	1
170508PEER-L	●	○	-	●	○	-	●	●	●	-	-	●	0,8	1
170512PEER-L	●		-	□		-	□	●	●	-	-		1,2	1
170516PEER-L	●		-	□		-	□	●	●	-	-		1,6	1
AOMT 170502PEER-G	●		□	●		□	●	●	●	-	-	□	0,2	1
170504PEER-G	●	○	●	●	○	●	●	●	●	-	-	●	0,4	1
170505PEER-G	●		□	□		□	□	●	●	-	-	□	0,5	1
170508PEER-G	●	○	●	●	○	●	●	●	●	-	-	●	0,8	1
170510PEER-G	●		□	□		□	□	●	●	-	-	□	1,0	1
170512PEER-G	●		□	●		□	●	●	●	-	-	□	1,2	1
170516PEER-G	●		□	●		□	●	●	●	-	-		1,6	1
170520PEER-G	●		□	●		□	●	●	●	-	-		2,0	1
170524PEER-G	●		□	□		□	□	●	●	-	-		2,4	1
170530PEER-G	●		□	●		□	●	●	●	-	-		3,0	1
170532PEER-G	●		□	□		□	●	●	●	-	-		3,2	1
170540PEER-G	●		□	●		□	●	●	●	-	-		4,0	1
170550PEER-G	●		□	●		□	●	●	●	-	-		5,0	2
170564PEER-G	●		□	□		□	□	●	●	-	-		6,4	2
AOMT 170504PEER-H	●	○	●	●	○	●	●	●	●	-	-	-	0,4	1
170508PEER-H	●	○	●	●	○	●	●	●	●	-	-	-	0,8	1
170512PEER-H	●		□	□		□	□	●	●	-	-	-	1,2	1
170516PEER-H	●		□	●		□	□	●	●	-	-	-	1,6	1
AOET 170502PEER-F	●		-			-	-	-	-	-	-	-	0,2	1
170504PEER-F	●		-			-	-	-	-	-	-	-	0,4	1
170505PEER-F	●		-			-	-	-	-	-	-	-	0,5	1
170508PEER-F	●		-			-	-	-	-	-	-	-	0,8	1
170510PEER-F	●		-			-	-	-	-	-	-	-	1,0	1
170512PEER-F	●		-			-	-	-	-	-	-	-	1,2	1
170516PEER-F	●		-			-	-	-	-	-	-	-	1,6	1
170520PEER-F	●		-			-	-	-	-	-	-	-	2,0	1
170524PEER-F	●		-			-	-	-	-	-	-	-	2,4	1
170530PEER-F	●		-			-	-	-	-	-	-	-	3,0	1
170532PEER-F	●		-			-	-	-	-	-	-	-	3,2	1
170540PEER-F	●		-			-	-	-	-	-	-	-	4,0	1
170550PEER-F	●		-			-	-	-	-	-	-	-	5,0	2
170564PEER-F	●		-			-	-	-	-	-	-	-	6,4	2
AOET 170502PEFR-S	-	-	-	-	-	-	-	-	●	●	-	-	0,2	1
170504PEFR-S	-	-	-	-	-	-	-	-	●	●	-	-	0,4	1
170505PEFR-S	-	-	-	-	-	-	-	-	●	●	-	-	0,5	1
170508PEFR-S	-	-	-	-	-	-	-	-	●	●	-	-	0,8	1
170510PEFR-S	-	-	-	-	-	-	-	-	●	●	-	-	1,0	1
170512PEFR-S	-	-	-	-	-	-	-	-	●	●	-	-	1,2	1
170516PEFR-S	-	-	-	-	-	-	-	-	●	●	-	-	1,6	1
170520PEFR-S	-	-	-	-	-	-	-	-	●	●	-	-	2,0	1
170524PEFR-S	-	-	-	-	-	-	-	-	●	●	-	-	2,4	1
170530PEFR-S	-	-	-	-	-	-	-	-	●	●	-	-	3,0	1
170532PEFR-S	-	-	-	-	-	-	-	-	●	●	-	-	3,2	1
170540PEFR-S	-	-	-	-	-	-	-	-	●	●	-	-	4,0	1
170550PEFR-S	-	-	-	-	-	-	-	-	●	●	-	-	5,0	2
170564PEFR-S	-	-	-	-	-	-	-	-	●	●	-	-	6,4	2

Fig. 1

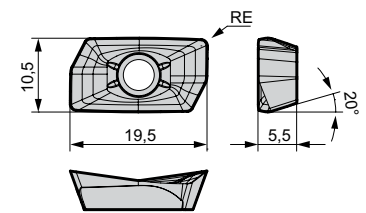
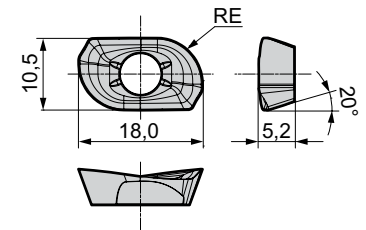

Fig. 2



L: Low cutting force
G: General purpose
H: Strong edge
F: Finishing
P: High-precision machining
S: Non ferrous metals

"WaveMill" Series WEZ 11000 E



Fig. 1

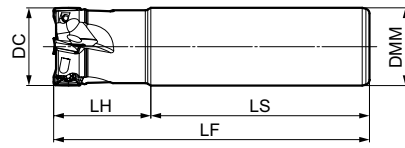
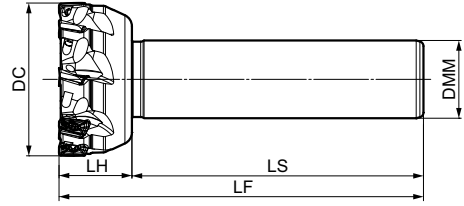

Fig. 2



Rake Angle	Radial	-7° -- -18°	10 mm	90°
	Axial	6° -- 15°		

Body - WEZ (Shank Type)

Dimensions (mm)

Cat. No.	Stock	DC	DMM	LH	LS	LF	No. of Teeth	Weight (kg)	Fig.
WEZ 11014E01	●	14	16	25	55	80	1	0,10	1
11016E02	●	16	16	25	75	100	2	0,13	1
11016E02-12	●	16	12	25	75	100	2	0,07	2
11018E02	●	18	16	25	75	100	2	0,13	2
11020E02	●	20	20	30	80	110	2	0,23	1
11020E02-16	●	20	16	30	80	110	2	0,15	2
11020E03	●	20	20	30	80	110	3	0,22	1
11020E03-16	●	20	16	30	80	110	3	0,14	2
11022E03	●	22	20	30	80	110	3	0,23	1
11025E02	●	25	25	35	85	120	2	0,40	1
11025E03	●	25	25	35	85	120	3	0,40	1
11025E03-20	●	25	20	35	85	120	3	0,26	2
11025E04	●	25	25	35	85	120	4	0,39	2
11025E04-20	●	25	20	35	85	120	4	0,26	2
11028E04	●	28	25	35	85	120	4	0,41	1
11030E04	●	30	25	40	90	130	4	0,46	1
11032E02	●	32	32	40	90	130	2	0,74	1
11032E03	●	32	32	40	90	130	3	0,73	1
11032E04	●	32	32	40	90	130	4	0,73	2
11032E05	●	32	32	40	90	130	5	0,72	2
11032E05-25	●	32	25	40	90	130	5	0,46	2
11035E05	●	35	32	40	90	130	5	0,75	2
11040E02	●	40	32	30	120	150	2	0,96	2
11040E04	●	40	32	30	120	150	4	0,94	2
11040E06	●	40	32	30	120	150	6	0,93	2
11050E05	●	50	32	30	120	150	5	1,04	2
11050E07	●	50	32	30	120	150	7	1,04	2
11063E08	●	63	32	30	120	150	8	1,24	2
11080E10	●	80	32	30	120	150	10	1,52	2

Inserts are sold separately.

Spare Parts

Applicable Cutters	Insert Screw		Wrench
WEZ 11014E01 11016E02(-12) 11018E02	BFTX0305IP	2,0	TRDR08IP
11020E02(-16) 11020E03(-16) 11022E03 11025E02 11025E03(-20) 11025E04(-20) 11028E04 11030E04 11032E02 11032E03 11032E04 11032E05(-25) 11035E05 11040E02 11040E04 11040E06 11050E05 11050E07 11063E08 11080E10		1,5	

Identification Details

WEZ	11	025	E	03	- 20
Cutter Series	Insert Size	Cutter Diameter	Round Shank	Number of Teeth	Shank Diameter

*When mounting inserts with nose radius of $\geq 2,4$ mm, modification of the body is required.



Modify this edge.

Reworking guidelines
 Corner radius = 2,4 mm: C = 1 mm (AOMT11T324PEER)
 Corner radius = 3,0 mm: C = 1 mm (AOMT11T330PEER)
 Corner radius = 3,2 mm: C = 1 mm (AOMT11T332PEER)
 Standard: R = 1 mm

C: Chamfer
 R: Radius

Inserts

Precautions for Mounting → P. 9

Application	Coated Carbide								Carbide	DLC	Cermet	RE	Fig.
	K	P	P	K	K	MS	MS	N					
High Speed / Light Cut													
General Purpose													
Roughing													
Cat. No.	ACU2500	XCU2500	ACP2000	ACP3000	XCK2000	ACK2000	ACK3000	ACM200	ACM300	H20	DL2000	T2500A	
AOMT 11T302PEER-G	●	○	□	●	○	□	●	●	●	-	-	●	0,2 1
11T304PEER-G	●	○	□	●	○	□	●	●	●	-	-	●	0,4 1
11T305PEER-G	●	○	□	●	○	□	●	●	●	-	-	□	0,5 1
11T308PEER-G	●	○	□	●	○	□	●	●	●	-	-	●	0,8 1
11T310PEER-G	●	○	□	●	○	□	●	●	●	-	-	□	1,0 1
11T312PEER-G	●	○	□	●	○	□	●	●	●	-	-	□	1,2 1
11T316PEER-G	●	○	□	●	○	□	●	●	●	-	-	-	1,6 1
11T320PEER-G	●	○	□	●	○	□	●	●	●	-	-	-	2,0 1
11T324PEER-G	●	○	□	●	○	□	●	●	●	-	-	-	2,4 1
11T330PEER-G	●	○	□	●	○	□	●	●	●	-	-	-	3,0 2
11T332PEER-G	●	○	□	●	○	□	●	●	●	-	-	-	3,2 2
AOMT 11T304PEER-H	●	○	□	●	○	□	●	●	●	-	-	-	0,4 1
11T308PEER-H	●	○	□	●	○	□	●	●	●	-	-	-	0,8 1
11T312PEER-H	●	○	□	●	○	□	●	●	●	-	-	-	1,2 1
11T316PEER-H	●	○	□	●	○	□	●	●	●	-	-	-	1,6 1
AOET 11T302PEER-F	●	-	-	-	-	-	-	-	-	-	-	-	0,2 1
11T304PEER-F	●	-	-	-	-	-	-	-	-	-	-	-	0,4 1
11T305PEER-F	●	-	-	-	-	-	-	-	-	-	-	-	0,5 1
11T308PEER-F	●	-	-	-	-	-	-	-	-	-	-	-	0,8 1
11T310PEER-F	●	-	-	-	-	-	-	-	-	-	-	-	1,0 1
11T312PEER-F	●	-	-	-	-	-	-	-	-	-	-	-	1,2 1
11T316PEER-F	●	-	-	-	-	-	-	-	-	-	-	-	1,6 1
11T320PEER-F	●	-	-	-	-	-	-	-	-	-	-	-	2,0 1
11T324PEER-F	●	-	-	-	-	-	-	-	-	-	-	-	2,4 1
11T330PEER-F	●	-	-	-	-	-	-	-	-	-	-	-	3,0 2
11T332PEER-F	●	-	-	-	-	-	-	-	-	-	-	-	3,2 2
AOET 11T302PEER-P16	●	-	-	-	-	-	-	-	-	-	-	-	0,2 1
11T304PEER-P16	●	-	-	-	-	-	-	-	-	-	-	-	0,4 1
11T305PEER-P16	●	-	-	-	-	-	-	-	-	-	-	-	0,5 1
11T308PEER-P16	●	-	-	-	-	-	-	-	-	-	-	-	0,8 1
11T310PEER-P16	●	-	-	-	-	-	-	-	-	-	-	-	1,0 1
11T312PEER-P16	●	-	-	-	-	-	-	-	-	-	-	-	1,2 1
11T302PEER-P20	●	-	-	-	-	-	-	-	-	-	-	-	0,2 1
11T304PEER-P20	●	-	-	-	-	-	-	-	-	-	-	-	0,4 1
11T305PEER-P20	●	-	-	-	-	-	-	-	-	-	-	-	0,5 1
11T308PEER-P20	●	-	-	-	-	-	-	-	-	-	-	-	0,8 1
11T310PEER-P20	●	-	-	-	-	-	-	-	-	-	-	-	1,0 1
11T312PEER-P20	●	-	-	-	-	-	-	-	-	-	-	-	1,2 1
11T302PEER-P25	●	-	-	-	-	-	-	-	-	-	-	-	0,2 1
11T304PEER-P25	●	-	-	-	-	-	-	-	-	-	-	-	0,4 1
11T305PEER-P25	●	-	-	-	-	-	-	-	-	-	-	-	0,5 1
11T308PEER-P25	●	-	-	-	-	-	-	-	-	-	-	-	0,8 1
11T310PEER-P25	●	-	-	-	-	-	-	-	-	-	-	-	1,0 1
11T312PEER-P25	●	-	-	-	-	-	-	-	-	-	-	-	1,2 1
AOET 11T302PEFR-S	-	-	-	-	-	-	-	-	-	●	●	-	0,2 1
11T304PEFR-S	-	-	-	-	-	-	-	-	-	●	●	-	0,4 1
11T305PEFR-S	-	-	-	-	-	-	-	-	-	●	●	-	0,5 1
11T308PEFR-S	-	-	-	-	-	-	-	-	-	●	●	-	0,8 1
11T310PEFR-S	-	-	-	-	-	-	-	-	-	●	●	-	1,0 1
11T312PEFR-S	-	-	-	-	-	-	-	-	-	●	●	-	1,2 1
11T316PEFR-S	-	-	-	-	-	-	-	-	-	●	●	-	1,6 1
11T320PEFR-S	-	-	-	-	-	-	-	-	-	●	●	-	2,0 1
11T324PEFR-S	-	-	-	-	-	-	-	-	-	●	●	-	2,4 1
11T330PEFR-S	-	-	-	-	-	-	-	-	-	●	●	-	3,0 2
11T332PEFR-S	-	-	-	-	-	-	-	-	-	●	●	-	3,2 2

Dimensions (mm)

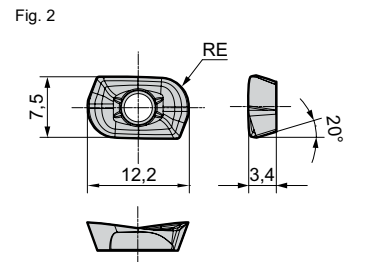
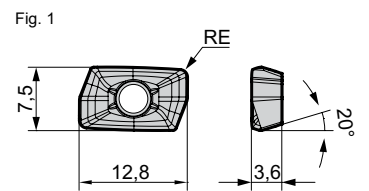

L: Low cutting force
G: General purpose
H: Strong edge
F: Finishing
P: High-precision machining
S: Non ferrous metals

*P16 is applicable to cutter diameters Ø 14 mm and Ø 16 mm.
*P20 is applicable to cutter diameters Ø 18 mm, Ø 20 mm.
*P25 is applicable to cutter diameters Ø 25 mm, Ø 28 mm.

Recommended Cutting Conditions

→ P. 8

● = Euro stock
○ = Japan stock

□ = On request

□ = Not available

Rake Angle	Radial	-14° - -18°	10 mm	90°
	Axial	6° - 10°		



Fig. 1

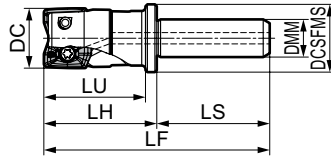
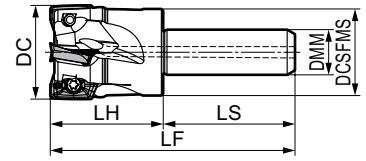

Fig. 2



Body - WEZ (Short Shank Type)

Dimensions (mm)

Cat. No.	Stock	DC	DCSFMS	DMM	LH	LU	LS	LF	No. of Teeth	Weight (kg)	Fig.
WEZ 11014ES01-12	●	14	18	12	30	27	35	65	1	0,05	1
11016ES02-10	●	16	18	10	25	22	30	55	2	0,04	1
11016ES02-12	●	16	18	12	30	27	35	65	2	0,05	1
11020ES03-10	●	20	18	10	25	-	30	55	3	0,04	2
11020ES03-12	●	20	18	12	30	-	35	65	3	0,06	2
11020ES03-16	●	20	23	16	30	27	40	70	3	0,10	1
11025ES04-12	●	25	23	12	30	-	35	65	4	0,09	2
11025ES04-16	●	25	23	16	30	-	40	70	4	0,12	2

Inserts are sold separately.

Spare Parts

Applicable Cutters	Insert Screw		Wrench
WEZ 11014ES01-12	BFTX0305IP	1,5	TRDR08IP
11016ES02-10			
11016ES02-12			
11020ES03-10			
11020ES03-12	BFTX0306IP	1,5	TRDR08IP
11020ES03-16			
11025ES04-12			
11025ES04-16			

Identification Details

WEZ	11	020	E	S	03	- 12
Cutter Series	Insert Size	Cutter Diameter	Round Shank	Short Shank	Number of Teeth	Shank Diameter

Recommended Cutting Conditions → P. 8

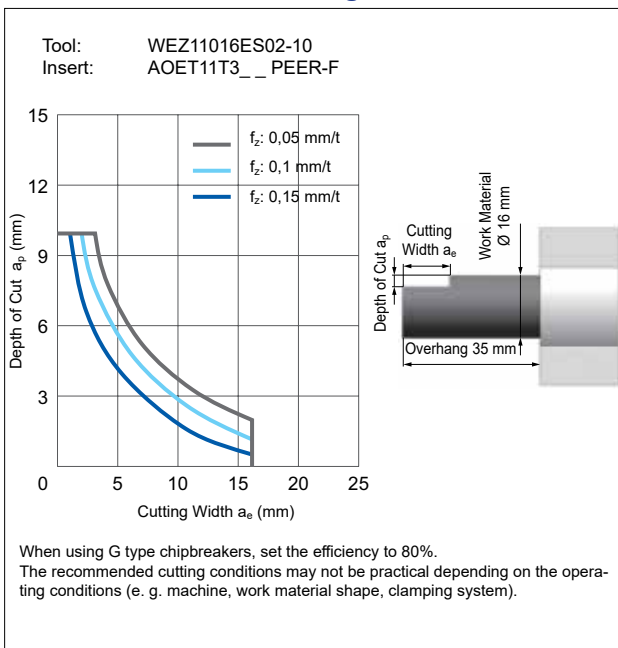

*When mounting inserts with nose radius of $\geq 2,4$ mm, modification of the body is required.

Modify this edge.

Reworking guidelines
 Corner radius = 2,4 mm: C = 1 mm (AOMT11T324PEER)
 Corner radius = 3,0 mm: C = 1 mm (AOMT11T330PEER)
 Corner radius = 3,2 mm: C = 1 mm (AOMT11T332PEER)
 Standard: R = 1 mm

C: Chamfer
R: Radius

Inserts

Precautions for Mounting → P. 9

Application	Coated Carbide								Carbide	DLC	Cermet	Dimensions (mm)		
	KM	P	K	K	MS	MS	N	N						
High Speed / Light Cut														
General Purpose														
Roughing														
Cat. No.	ACU2500	XCU2500	ACP2000	ACP3000	XCK2000	ACK2000	ACK3000	ACM200	ACM300	H20	DL2000	T2500A	RE	Fig.
AOMT 11T302PEER-G	●		□	●		□	●	●	●	-	-	●	0,2	1
11T304PEER-G	●	○	●	●	○	●	●	●	●	-	-	●	0,4	1
11T305PEER-G	●		□	□		□	□	□	□	-	-	□	0,5	1
11T308PEER-G	●	○	●	●	○	●	●	●	●	-	-	●	0,8	1
11T310PEER-G	●		□	□		□	□	□	□	-	-	□	1,0	1
11T312PEER-G	●		□	●		□	●	●	●	-	-	□	1,2	1
11T316PEER-G	●		□	●		□	●	●	●	-	-		1,6	1
11T320PEER-G	●		□	●		□	●	●	●	-	-		2,0	1
11T324PEER-G	●		□	□		□	□	□	□	-	-		2,4	1
11T330PEER-G	●		□	●		□	●	●	●	-	-		3,0	2
11T332PEER-G	●		□	□		□	□	□	□	-	-		3,2	2
AOMT 11T304PEER-H	●	○	●	●	○	●	●	●	●	-	-	-	0,4	1
11T308PEER-H	●	○	●	●	○	●	●	●	●	-	-	-	0,8	1
11T312PEER-H	●		□	□		□	□	□	□	-	-	-	1,2	1
11T316PEER-H	●		□	□		□	□	□	□	-	-	-	1,6	1
AOET 11T302PEER-F	●		-			-	-	-	-	-	-	-	0,2	1
11T304PEER-F	●		-			-	-	-	-	-	-	-	0,4	1
11T305PEER-F	●		-			-	-	-	-	-	-	-	0,5	1
11T308PEER-F	●		-			-	-	-	-	-	-	-	0,8	1
11T310PEER-F	●		-			-	-	-	-	-	-	-	1,0	1
11T312PEER-F	●		-			-	-	-	-	-	-	-	1,2	1
11T316PEER-F	●		-			-	-	-	-	-	-	-	1,6	1
11T320PEER-F	●		-			-	-	-	-	-	-	-	2,0	1
11T324PEER-F	●		-			-	-	-	-	-	-	-	2,4	1
11T330PEER-F	●		-			-	-	-	-	-	-	-	3,0	2
11T332PEER-F	●		-			-	-	-	-	-	-	-	3,2	2
AOET 11T302PEER-P16	●		-			-	-	-	-	-	-	-	0,2	1
11T304PEER-P16	●		-			-	-	-	-	-	-	-	0,4	1
11T305PEER-P16	●		-			-	-	-	-	-	-	-	0,5	1
11T308PEER-P16	●		-			-	-	-	-	-	-	-	0,8	1
11T310PEER-P16	●		-			-	-	-	-	-	-	-	1,0	1
11T312PEER-P16	●		-			-	-	-	-	-	-	-	1,2	1
11T302PEER-P20	●		-			-	-	-	-	-	-	-	0,2	1
11T304PEER-P20	●		-			-	-	-	-	-	-	-	0,4	1
11T305PEER-P20	●		-			-	-	-	-	-	-	-	0,5	1
11T308PEER-P20	●		-			-	-	-	-	-	-	-	0,8	1
11T310PEER-P20	●		-			-	-	-	-	-	-	-	1,0	1
11T312PEER-P20	●		-			-	-	-	-	-	-	-	1,2	1
11T302PEER-P25	●		-			-	-	-	-	-	-	-	0,2	1
11T304PEER-P25	●		-			-	-	-	-	-	-	-	0,4	1
11T305PEER-P25	●		-			-	-	-	-	-	-	-	0,5	1
11T308PEER-P25	●		-			-	-	-	-	-	-	-	0,8	1
11T310PEER-P25	●		-			-	-	-	-	-	-	-	1,0	1
11T312PEER-P25	●		-			-	-	-	-	-	-	-	1,2	1
AOET 11T302PEFR-S	-	-	-	-	-	-	-	-	-	●	●	-	0,2	1
11T304PEFR-S	-	-	-	-	-	-	-	-	-	●	●	-	0,4	1
11T305PEFR-S	-	-	-	-	-	-	-	-	-	●	●	-	0,5	1
11T308PEFR-S	-	-	-	-	-	-	-	-	-	●	●	-	0,8	1
11T310PEFR-S	-	-	-	-	-	-	-	-	-	●	●	-	1,0	1
11T312PEFR-S	-	-	-	-	-	-	-	-	-	●	●	-	1,2	1
11T316PEFR-S	-	-	-	-	-	-	-	-	-	●	●	-	1,6	1
11T320PEFR-S	-	-	-	-	-	-	-	-	-	●	●	-	2,0	1
11T324PEFR-S	-	-	-	-	-	-	-	-	-	●	●	-	2,4	1
11T330PEFR-S	-	-	-	-	-	-	-	-	-	●	●	-	3,0	2
11T332PEFR-S	-	-	-	-	-	-	-	-	-	●	●	-	3,2	2

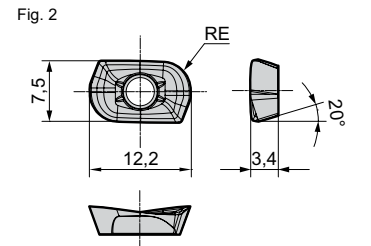
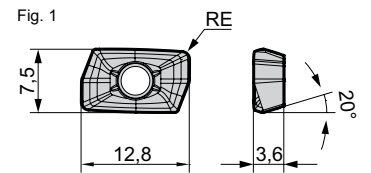

L: Low cutting force
 G: General purpose
 H: Strong edge
 F: Finishing
 P: High-precision machining
 S: Non ferrous metals

*P16 is applicable to cutter diameters Ø 14 mm and Ø 16 mm.

*P20 is applicable to cutter diameters Ø 18 mm, Ø 20 mm.

*P25 is applicable to cutter diameters Ø 25 mm, Ø 28 mm.

"WaveMill" Series WEZ 11000 EL

Rake Angle	Radial	-7° – -18°	10 mm	90°
	Axial	6° – 15°		



Fig. 1

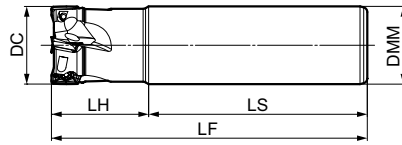
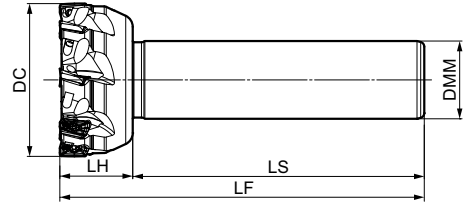

Fig. 2



Body - WEZ (Long Type)

Dimensions (mm)

Cat. No.	Stock	DC	DMM	LH	LS	LF	No. of Teeth	Weight (kg)	Fig.
WEZ 11014EL01	●	14	16	25	95	120	1	0,16	1
11016EL02	●	16	16	25	120	145	2	0,19	1
11016EL02-14	●	16	14	25	120	145	2	0,15	2
11018EL02	●	18	16	25	120	145	2	0,20	2
11020EL02	●	20	20	40	110	150	2	0,31	1
11020EL02-18	●	20	18	25	125	150	2	0,26	2
11022EL02	●	22	20	30	120	150	2	0,32	2
11025EL02	●	25	25	50	120	170	2	0,57	1
11025EL02-22	●	25	22	30	140	170	2	0,46	2
11025EL03	●	25	25	50	120	170	3	0,57	1
11028EL02	●	28	25	30	140	170	2	0,60	2
11030EL02	●	30	25	30	140	170	2	0,62	2
11032EL02	●	32	32	60	110	170	2	0,97	1
11032EL02-30	●	32	30	30	140	170	2	0,88	2
11032EL03	●	32	32	60	110	170	3	0,96	1
11035EL02	●	35	32	30	140	170	2	1,02	2
11035EL03	●	35	32	30	140	170	3	1,00	2
11040EL02	●	40	32	30	140	170	2	1,08	2
11050EL03	●	50	32	30	140	170	3	1,19	2

Inserts are sold separately.

Spare Parts

Applicable Cutters	Insert Screw		Wrench	
WEZ 11014EL01	BFTX0305IP	1,5	TRDR08IP	
11016EL02(-14)				
11018EL02				
11020EL02(-18)				
11022EL02				
11025EL02(-22)				
11025EL03				
11028EL02				
11030EL02				
11032EL02(-30)				
11032EL03				
11035EL02				
11035EL03				
11040EL02				
11050EL03				

Identification Details

WEZ	11	025	E	L	02	- 22
Cutter Series	Insert Size	Cutter Diameter	Round-Shank	Long Type	Number of Teeth	Shank Diameter

*When mounting inserts with nose radius of $\geq 2,4$ mm, modification of the body is required.

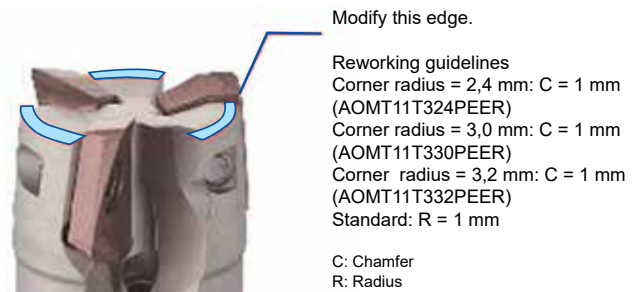

Recommended Cutting Conditions

→ P. 8

Inserts

Precautions for Mounting → P. 9

Application	Coated Carbide								Carbide	DLC	Cermet	Dimensions (mm)		
	KM	P	K	K	MS	MS	N	N						
High Speed / Light Cut														
General Purpose														
Roughing														
Cat. No.	ACU2500	XCU2500	ACP2000	ACP3000	XCK2000	ACK2000	ACK3000	ACM200	ACM300	H20	DL2000	T2500A	RE	Fig.
AOMT 11T302PEER-G	●	○	□	●	○	□	●	●	●	-	-	●	0,2	1
11T304PEER-G	●	○	□	●	○	□	●	●	●	-	-	●	0,4	1
11T305PEER-G	●	○	□	●	○	□	●	●	●	-	-	□	0,5	1
11T308PEER-G	●	○	□	●	○	□	●	●	●	-	-	●	0,8	1
11T310PEER-G	●	○	□	●	○	□	●	●	●	-	-	□	1,0	1
11T312PEER-G	●	○	□	●	○	□	●	●	●	-	-	□	1,2	1
11T316PEER-G	●	○	□	●	○	□	●	●	●	-	-	-	1,6	1
11T320PEER-G	●	○	□	●	○	□	●	●	●	-	-	-	2,0	1
11T324PEER-G	●	○	□	●	○	□	●	●	●	-	-	-	2,4	1
11T330PEER-G	●	○	□	●	○	□	●	●	●	-	-	-	3,0	2
11T332PEER-G	●	○	□	●	○	□	●	●	●	-	-	-	3,2	2
AOMT 11T304PEER-H	●	○	□	●	○	□	●	●	●	-	-	-	0,4	1
11T308PEER-H	●	○	□	●	○	□	●	●	●	-	-	-	0,8	1
11T312PEER-H	●	○	□	●	○	□	●	●	●	-	-	-	1,2	1
11T316PEER-H	●	○	□	●	○	□	●	●	●	-	-	-	1,6	1
AOET 11T302PEER-F	●	-	-	-	-	-	-	-	-	-	-	-	0,2	1
11T304PEER-F	●	-	-	-	-	-	-	-	-	-	-	-	0,4	1
11T305PEER-F	●	-	-	-	-	-	-	-	-	-	-	-	0,5	1
11T308PEER-F	●	-	-	-	-	-	-	-	-	-	-	-	0,8	1
11T310PEER-F	●	-	-	-	-	-	-	-	-	-	-	-	1,0	1
11T312PEER-F	●	-	-	-	-	-	-	-	-	-	-	-	1,2	1
11T316PEER-F	●	-	-	-	-	-	-	-	-	-	-	-	1,6	1
11T320PEER-F	●	-	-	-	-	-	-	-	-	-	-	-	2,0	1
11T324PEER-F	●	-	-	-	-	-	-	-	-	-	-	-	2,4	1
11T330PEER-F	●	-	-	-	-	-	-	-	-	-	-	-	3,0	2
11T332PEER-F	●	-	-	-	-	-	-	-	-	-	-	-	3,2	2
AOET 11T302PEER-P16	●	-	-	-	-	-	-	-	-	-	-	-	0,2	1
11T304PEER-P16	●	-	-	-	-	-	-	-	-	-	-	-	0,4	1
11T305PEER-P16	●	-	-	-	-	-	-	-	-	-	-	-	0,5	1
11T308PEER-P16	●	-	-	-	-	-	-	-	-	-	-	-	0,8	1
11T310PEER-P16	●	-	-	-	-	-	-	-	-	-	-	-	1,0	1
11T312PEER-P16	●	-	-	-	-	-	-	-	-	-	-	-	1,2	1
11T302PEER-P20	●	-	-	-	-	-	-	-	-	-	-	-	0,2	1
11T304PEER-P20	●	-	-	-	-	-	-	-	-	-	-	-	0,4	1
11T305PEER-P20	●	-	-	-	-	-	-	-	-	-	-	-	0,5	1
11T308PEER-P20	●	-	-	-	-	-	-	-	-	-	-	-	0,8	1
11T310PEER-P20	●	-	-	-	-	-	-	-	-	-	-	-	1,0	1
11T312PEER-P20	●	-	-	-	-	-	-	-	-	-	-	-	1,2	1
11T302PEER-P25	●	-	-	-	-	-	-	-	-	-	-	-	0,2	1
11T304PEER-P25	●	-	-	-	-	-	-	-	-	-	-	-	0,4	1
11T305PEER-P25	●	-	-	-	-	-	-	-	-	-	-	-	0,5	1
11T308PEER-P25	●	-	-	-	-	-	-	-	-	-	-	-	0,8	1
11T310PEER-P25	●	-	-	-	-	-	-	-	-	-	-	-	1,0	1
11T312PEER-P25	●	-	-	-	-	-	-	-	-	-	-	-	1,2	1
AOET 11T302PEFR-S	-	-	-	-	-	-	-	-	-	●	●	-	0,2	1
11T304PEFR-S	-	-	-	-	-	-	-	-	-	●	●	-	0,4	1
11T305PEFR-S	-	-	-	-	-	-	-	-	-	●	●	-	0,5	1
11T308PEFR-S	-	-	-	-	-	-	-	-	-	●	●	-	0,8	1
11T310PEFR-S	-	-	-	-	-	-	-	-	-	●	●	-	1,0	1
11T312PEFR-S	-	-	-	-	-	-	-	-	-	●	●	-	1,2	1
11T316PEFR-S	-	-	-	-	-	-	-	-	-	●	●	-	1,6	1
11T320PEFR-S	-	-	-	-	-	-	-	-	-	●	●	-	2,0	1
11T324PEFR-S	-	-	-	-	-	-	-	-	-	●	●	-	2,4	1
11T330PEFR-S	-	-	-	-	-	-	-	-	-	●	●	-	3,0	2
11T332PEFR-S	-	-	-	-	-	-	-	-	-	●	●	-	3,2	2

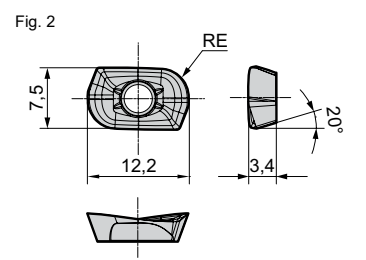
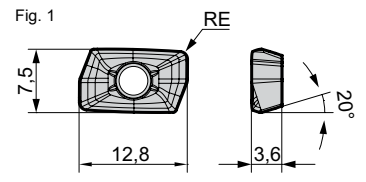

L: Low cutting force
 G: General purpose
 H: Strong edge
 F: Finishing
 P: High-precision machining
 S: Non ferrous metals

*P16 is applicable to cutter diameters Ø 14 mm and Ø 16 mm.
 *P20 is applicable to cutter diameters Ø 18 mm, Ø 20 mm.
 *P25 is applicable to cutter diameters Ø 25 mm, Ø 28 mm.

"WaveMill" Series WEZ 17000 E

Rake Angle	Radial	-6° - -12°	15 mm	90°
	Axial	6° - 15°		



Fig. 1

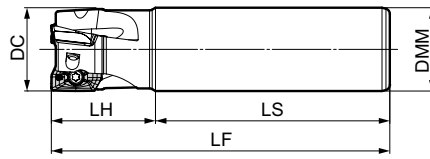
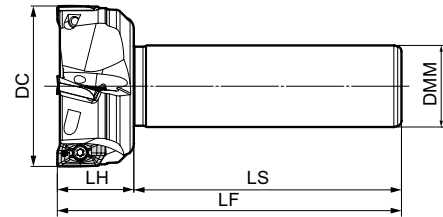

Fig. 2



Body - WEZ (Shank Type)

Dimensions (mm)

Cat. No.	Stock	DC	DMM	LH	LS	LF	No. of Teeth	Weight (kg)	Fig.
WEZ 17025E02	●	25	25	35	85	120	2	0,38	1
17025E02-20	●	25	20	35	85	120	2	0,25	2
17028E02	●	28	25	35	85	120	2	0,40	2
17030E03	●	30	25	40	90	130	3	0,43	2
17032E02	●	32	32	40	90	130	2	0,71	1
17032E03	●	32	32	40	90	130	3	0,69	1
17032E03-25	●	32	25	40	90	130	3	0,44	2
17035E03	●	35	32	40	90	130	3	0,72	2
17040E03	●	40	32	30	105	135	3	0,81	2
17040E04	●	40	32	30	105	135	4	0,79	2
17050E03	●	50	32	30	105	135	3	0,93	2
17050E03-42	●	50	42	30	105	135	3	1,41	2
17050E05	●	50	32	30	105	135	5	0,89	2
17050E05-42	●	50	42	30	105	135	5	1,37	2
17063E04	●	63	32	30	105	135	4	1,10	2
17063E04-42	●	63	42	30	105	135	4	1,58	2
17063E06	●	63	32	30	105	135	6	1,08	2
17063E06-42	●	63	42	30	105	135	6	1,56	2
17080E07	●	80	32	30	105	135	7	1,39	2

Inserts are sold separately.

Spare Parts

Applicable Cutters	Insert Screw		Wrench
WEZ 17025E02(-20)	BFTX0407IP	3,0	TRDR15IP
17028E02			
17030E03			
17032E02			
17032E03(-25)			
17035E03			
17040E03			
17040E04			
17050E03(-42)			
17050E05(-42)			
17063E04(-42)			
17063E06(-42)			
17080E07			

Identification Details

WEZ	17	025	E	02	- 20
Cutter Series	Insert Size	Cutter Diameter	Round Shank	Number of Teeth	Shank Diameter

*When mounting inserts with nose radius of $\geq 2,4$ mm, modification of the body is required.



Modify this edge.

Reworking guidelines

- Corner radius = 2,4 mm: C = 1 mm (AOMT170524PEER)
- Corner radius = 3,0 mm: C = 1 mm (AOMT170530PEER)
- Corner radius = 3,2 mm: C = 1 mm (AOMT170532PEER)
- Corner radius = 4,0 mm: C = 2 mm (AOMT170540PEER)
- Corner radius = 5,0 mm: C = 5 mm (AOMT170550PEER)
- Corner radius = 6,4 mm: C = 5 mm (AOMT170564PEER)
- Standard: R = 1 mm

C: Chamfer
R: Radius

Recommended Cutting Conditions

→ P. 8

Inserts

Precautions for Mounting → P. 9

Application	Coated Carbide								Carbide	DLC	Cermat	Dimensions (mm)		
	K	P	K	K	M	M	N	P						
High Speed / Light Cut														
General Purpose														
Roughing														
Cat. No.	ACU2500	XCU2500	ACP2000	ACP3000	XCK2000	ACK2000	ACK3000	ACM200	ACM300	H20	DL2000	T2500A	RE	Fig.
AOMT 170502PEER-L	●												0,2	1
170504PEER-L	●	○											0,4	1
170508PEER-L	●	○											0,8	1
170512PEER-L	●												1,2	1
170516PEER-L	●												1,6	1
AOMT 170502PEER-G	●												0,2	1
170504PEER-G	●	○											0,4	1
170505PEER-G	●												0,5	1
170508PEER-G	●	○											0,8	1
170510PEER-G	●												1,0	1
170512PEER-G	●												1,2	1
170516PEER-G	●												1,6	1
170520PEER-G	●												2,0	1
170524PEER-G	●												2,4	1
170530PEER-G	●												3,0	1
170532PEER-G	●												3,2	1
170540PEER-G	●												4,0	1
170550PEER-G	●												5,0	2
170564PEER-G	□												6,4	2
AOMT 170504PEER-H	●	○											0,4	1
170508PEER-H	●	○											0,8	1
170512PEER-H	●												1,2	1
170516PEER-H	●												1,6	1
AOET 170502PEER-F	●												0,2	1
170504PEER-F	●												0,4	1
170505PEER-F	●												0,5	1
170508PEER-F	●												0,8	1
170510PEER-F	●												1,0	1
170512PEER-F	●												1,2	1
170516PEER-F	●												1,6	1
170520PEER-F	●												2,0	1
170524PEER-F	●												2,4	1
170530PEER-F	●												3,0	1
170532PEER-F	●												3,2	1
170540PEER-F	●												4,0	1
170550PEER-F	●												5,0	2
170564PEER-F	●												6,4	2
AOET 170502PEER-P25	●												0,2	1
170504PEER-P25	●												0,4	1
170505PEER-P25	●												0,5	1
170508PEER-P25	●												0,8	1
170510PEER-P25	●												1,0	1
170512PEER-P25	●												1,2	1
170502PEER-P32	●												0,2	1
170504PEER-P32	●												0,4	1
170505PEER-P32	●												0,5	1
170508PEER-P32	●												0,8	1
170510PEER-P32	●												1,0	1
170512PEER-P32	●												1,2	1
AOET 170502PEFR-S	-	-	-	-	-	-	-	-	-	●	●	-	0,2	1
170504PEFR-S	-	-	-	-	-	-	-	-	-	●	●	-	0,4	1
170505PEFR-S	-	-	-	-	-	-	-	-	-	●	●	-	0,5	1
170508PEFR-S	-	-	-	-	-	-	-	-	-	●	●	-	0,8	1
170510PEFR-S	-	-	-	-	-	-	-	-	-	●	●	-	1,0	1
170512PEFR-S	-	-	-	-	-	-	-	-	-	●	●	-	1,2	1
170516PEFR-S	-	-	-	-	-	-	-	-	-	●	●	-	1,6	1
170520PEFR-S	-	-	-	-	-	-	-	-	-	●	●	-	2,0	1
170524PEFR-S	-	-	-	-	-	-	-	-	-	●	●	-	2,4	1
170530PEFR-S	-	-	-	-	-	-	-	-	-	●	●	-	3,0	1
170532PEFR-S	-	-	-	-	-	-	-	-	-	●	●	-	3,2	1
170540PEFR-S	-	-	-	-	-	-	-	-	-	●	●	-	4,0	1
170550PEFR-S	-	-	-	-	-	-	-	-	-	●	●	-	5,0	2
170564PEFR-S	-	-	-	-	-	-	-	-	-	●	●	-	6,4	2

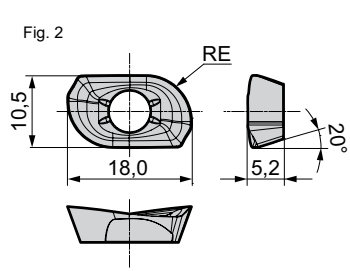
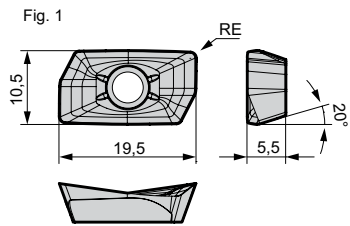

L: Low cutting force
 G: General purpose
 H: Strong edge
 F: Finishing
 P: High-precision machining
 S: Non ferrous metals

*P25 is applicable to cutter diameters Ø 25 mm and Ø 28 mm.
 *P32 is applicable to cutter diameters Ø 30 mm, Ø 32 mm and Ø 35 mm.

"WaveMill" Series WEZ 17000 ES

Series for Multi-Tasking Machines

Rake Angle	Radial	-10° -- -12°	15 mm	90°
	Axial	6° -- 8°		



Fig. 1

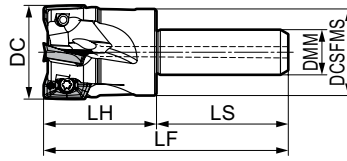

Body - WEZ (Short Shank Type)

Dimensions (mm)

Cat. No.	Stock	DC	DCSFMS	DMM	LH	LS	LF	No. of Teeth	Weight (kg)	Fig.
WEZ 17025ES02-16	●	25	23	16	30	40	70	2	0,11	1
17032ES03-16	●	32	27	16	30	40	70	3	0,14	1

Inserts are sold separately.

Spare Parts

Applicable Cutters	Insert Screw		Wrench
	WEZ 17025ES02-16 17032ES03-16		
	BFTX0407IP BFTX0409IP	3,0	TRDR15IP

Identification Details

WEZ 17 025 E S 02 - 16

Cutter Series Insert Size Cutter Diameter Round Shank Short Shank Number of Teeth Shank Diameter

*When mounting inserts with nose radius of $\geq 2,4$ mm, modification of the body is required.



Modify this edge.

Reworking guidelines

Corner radius = 2,4 mm: C = 1 mm (AOMT170524PEER)

Corner radius = 3,0 mm: C = 1 mm (AOMT170530PEER)

Corner radius = 3,2 mm: C = 1 mm (AOMT170532PEER)

Corner radius = 4,0 mm: C = 2 mm (AOMT170540PEER)

Corner radius = 5,0 mm: C = 5 mm (AOMT170550PEER)

Corner radius = 6,4 mm: C = 5 mm (AOMT170564PEER)

Standard: R = 1 mm

C: Chamfer

R: Radius

Recommended Cutting Conditions

→ P. 8

Tool: WEZ17025ES02-16
Insert: AOET1705_ PEER-F

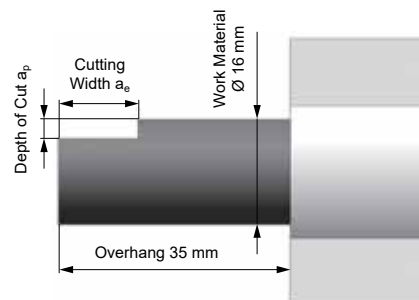
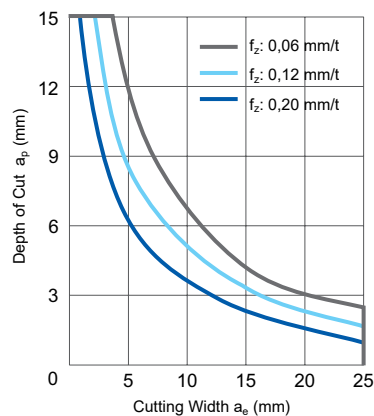

When using G type chipbreakers, set the efficiency to 80%.

The recommended cutting conditions may not be practical depending on the operating conditions (e. g. machine, work material shape, clamping system).

Inserts

Precautions for Mounting

→ P. 9

Application	Coated Carbide								Carbide	DLC	Cermat	Dimensions (mm)		
	KP	PM	P	K	K	MS	MS	MS						
High Speed / Light Cut										N	P			
General Purpose										N	N			
Roughing														
Cat. No.	ACU2500	XCU2500	ACP2000	ACP3000	XCK2000	ACK2000	ACK3000	ACM200	ACM300	H20	DL2000	T2500A	RE	Fig.
AOMT 170502PEER-L	●			□				●	●				0,2	1
170504PEER-L	●	○		●	○			●	●				0,4	1
170508PEER-L	●	○		●	○			●	●				0,8	1
170512PEER-L	●			□				●	●				1,2	1
170516PEER-L	●			□				●	●				1,6	1
AOMT 170502PEER-G	●			□				●	●				0,2	1
170504PEER-G	●	○	●	●	○	●		●	●				0,4	1
170505PEER-G	●		□	□		□		●	●				0,5	1
170508PEER-G	●	○	●	●	○	●		●	●				0,8	1
170510PEER-G	●		□	□		□		●	●				1,0	1
170512PEER-G	●		□	●		□		●	●				1,2	1
170516PEER-G	●		□	●		□		●	●				1,6	1
170520PEER-G	●		□	●		□		●	●				2,0	1
170524PEER-G	●		□	●		□		●	●				2,4	1
170530PEER-G	●		□	●		□		●	●				3,0	1
170532PEER-G	●		□	●		□		●	●				3,2	1
170540PEER-G	●		□	●		□		●	●				4,0	1
170550PEER-G	●		□	●		□		●	●				5,0	2
170564PEER-G	□		□	□		□		●	●				6,4	2
AOMT 170504PEER-H	●	○	●	●	○	●		●	●				0,4	1
170508PEER-H	●	○	●	●	○	●		●	●				0,8	1
170512PEER-H	●		□	□		□		●	●				1,2	1
170516PEER-H	●		□	●		□		●	●				1,6	1
AOET 170502PEER-F	●												0,2	1
170504PEER-F	●												0,4	1
170505PEER-F	●												0,5	1
170508PEER-F	●												0,8	1
170510PEER-F	●												1,0	1
170512PEER-F	●												1,2	1
170516PEER-F	●												1,6	1
170520PEER-F	●												2,0	1
170524PEER-F	●												2,4	1
170530PEER-F	●												3,0	1
170532PEER-F	●												3,2	1
170540PEER-F	●												4,0	1
170550PEER-F	●												5,0	2
170564PEER-F	●												6,4	2
AOET 170502PEER-P25	●												0,2	1
170504PEER-P25	●												0,4	1
170505PEER-P25	●												0,5	1
170508PEER-P25	●												0,8	1
170510PEER-P25	●												1,0	1
170512PEER-P25	●												1,2	1
170502PEER-P32	●												0,2	1
170504PEER-P32	●												0,4	1
170505PEER-P32	●												0,5	1
170508PEER-P32	●												0,8	1
170510PEER-P32	●												1,0	1
170512PEER-P32	●												1,2	1
AOET 170502PEFR-S	-	-	-	-	-	-	-	-	●	●			0,2	1
170504PEFR-S	-	-	-	-	-	-	-	-	●	●			0,4	1
170505PEFR-S	-	-	-	-	-	-	-	-	●	●			0,5	1
170508PEFR-S	-	-	-	-	-	-	-	-	●	●			0,8	1
170510PEFR-S	-	-	-	-	-	-	-	-	●	●			1,0	1
170512PEFR-S	-	-	-	-	-	-	-	-	●	●			1,2	1
170516PEFR-S	-	-	-	-	-	-	-	-	●	●			1,6	1
170520PEFR-S	-	-	-	-	-	-	-	-	●	●			2,0	1
170524PEFR-S	-	-	-	-	-	-	-	-	●	●			2,4	1
170530PEFR-S	-	-	-	-	-	-	-	-	●	●			3,0	1
170532PEFR-S	-	-	-	-	-	-	-	-	●	●			3,2	1
170540PEFR-S	-	-	-	-	-	-	-	-	●	●			4,0	1
170550PEFR-S	-	-	-	-	-	-	-	-	●	●			5,0	2
170564PEFR-S	-	-	-	-	-	-	-	-	●	●			6,4	2

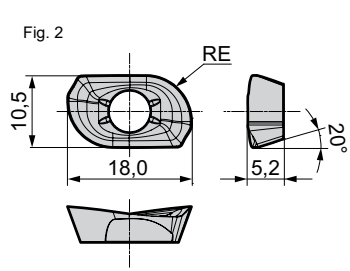
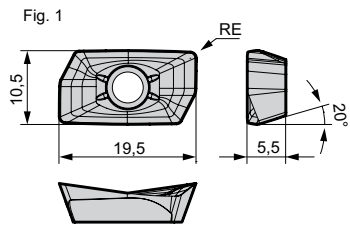

L: Low cutting force
 G: General purpose
 H: Strong edge
 F: Finishing
 P: High-precision machining
 S: Non ferrous metals

*P25 is applicable to cutter diameters Ø 25 mm and Ø 28 mm.
 *P32 is applicable to cutter diameters Ø 30 mm, Ø 32 mm and Ø 35 mm.

"Wave Mill" Series WEZ 17000 EL

Inserts

Precautions for Mounting → P. 9

Application	Coated Carbide								Carbide	DLC	Cermat	RE	Fig.	Dimensions (mm)
	P	K	K	M	M	S	S	S						
High Speed / Light Cut														
General Purpose														
Roughing														
Cat. No.	ACU2500	XCU2500	ACP2000	ACP3000	XCK2000	ACK2000	ACK3000	ACM200	ACM300	H20	DL2000	T2500A	RE	Fig.
AOMT 170502PEER-L	●	○	-	□	○	-	□	●	●	-	-	□	0,2	1
170504PEER-L	●	○	-	□	○	-	□	●	●	-	-	□	0,4	1
170508PEER-L	●	○	-	□	○	-	□	●	●	-	-	□	0,8	1
170512PEER-L	●	-	-	□	-	-	□	●	●	-	-	-	1,2	1
170516PEER-L	●	-	-	□	-	-	□	●	●	-	-	-	1,6	1
AOMT 170502PEER-G	●	○	□	□	○	□	□	●	●	-	-	□	0,2	1
170504PEER-G	●	○	□	□	○	□	□	●	●	-	-	□	0,4	1
170505PEER-G	●	-	□	□	-	□	□	●	●	-	-	□	0,5	1
170508PEER-G	●	○	□	□	○	□	□	●	●	-	-	□	0,8	1
170510PEER-G	●	-	□	□	-	□	□	●	●	-	-	□	1,0	1
170512PEER-G	●	-	□	□	-	□	□	●	●	-	-	□	1,2	1
170516PEER-G	●	-	□	□	-	□	□	●	●	-	-	-	1,6	1
170520PEER-G	●	-	□	□	-	□	□	●	●	-	-	-	2,0	1
170524PEER-G	●	-	□	□	-	□	□	●	●	-	-	-	2,4	1
170530PEER-G	●	-	□	□	-	□	□	●	●	-	-	-	3,0	1
170532PEER-G	●	-	□	□	-	□	□	●	●	-	-	-	3,2	1
170540PEER-G	●	-	□	□	-	□	□	●	●	-	-	-	4,0	1
170550PEER-G	●	-	□	□	-	□	□	●	●	-	-	-	5,0	2
170564PEER-G	□	-	□	□	-	□	□	●	●	-	-	-	6,4	2
AOMT 170504PEER-H	●	○	□	□	○	□	□	●	●	-	-	-	0,4	1
170508PEER-H	●	○	□	□	○	□	□	●	●	-	-	-	0,8	1
170512PEER-H	●	-	□	□	-	□	□	●	●	-	-	-	1,2	1
170516PEER-H	●	-	□	□	-	□	□	●	●	-	-	-	1,6	1
AOET 170502PEER-F	●	-	-	-	-	-	-	-	-	-	-	-	0,2	1
170504PEER-F	●	-	-	-	-	-	-	-	-	-	-	-	0,4	1
170505PEER-F	●	-	-	-	-	-	-	-	-	-	-	-	0,5	1
170508PEER-F	●	-	-	-	-	-	-	-	-	-	-	-	0,8	1
170510PEER-F	●	-	-	-	-	-	-	-	-	-	-	-	1,0	1
170512PEER-F	●	-	-	-	-	-	-	-	-	-	-	-	1,2	1
170516PEER-F	●	-	-	-	-	-	-	-	-	-	-	-	1,6	1
170520PEER-F	●	-	-	-	-	-	-	-	-	-	-	-	2,0	1
170524PEER-F	●	-	-	-	-	-	-	-	-	-	-	-	2,4	1
170530PEER-F	●	-	-	-	-	-	-	-	-	-	-	-	3,0	1
170532PEER-F	●	-	-	-	-	-	-	-	-	-	-	-	3,2	1
170540PEER-F	●	-	-	-	-	-	-	-	-	-	-	-	4,0	1
170550PEER-F	●	-	-	-	-	-	-	-	-	-	-	-	5,0	2
170564PEER-F	●	-	-	-	-	-	-	-	-	-	-	-	6,4	2
AOET 170502PEER-P25	●	-	-	-	-	-	-	-	-	-	-	-	0,2	1
170504PEER-P25	●	-	-	-	-	-	-	-	-	-	-	-	0,4	1
170505PEER-P25	●	-	-	-	-	-	-	-	-	-	-	-	0,5	1
170508PEER-P25	●	-	-	-	-	-	-	-	-	-	-	-	0,8	1
170510PEER-P25	●	-	-	-	-	-	-	-	-	-	-	-	1,0	1
170512PEER-P25	●	-	-	-	-	-	-	-	-	-	-	-	1,2	1
170502PEER-P32	●	-	-	-	-	-	-	-	-	-	-	-	0,2	1
170504PEER-P32	●	-	-	-	-	-	-	-	-	-	-	-	0,4	1
170505PEER-P32	●	-	-	-	-	-	-	-	-	-	-	-	0,5	1
170508PEER-P32	●	-	-	-	-	-	-	-	-	-	-	-	0,8	1
170510PEER-P32	●	-	-	-	-	-	-	-	-	-	-	-	1,0	1
170512PEER-P32	●	-	-	-	-	-	-	-	-	-	-	-	1,2	1
AOET 170502PEFR-S	-	-	-	-	-	-	-	-	●	●	-	-	0,2	1
170504PEFR-S	-	-	-	-	-	-	-	-	●	●	-	-	0,4	1
170505PEFR-S	-	-	-	-	-	-	-	-	●	●	-	-	0,5	1
170508PEFR-S	-	-	-	-	-	-	-	-	●	●	-	-	0,8	1
170510PEFR-S	-	-	-	-	-	-	-	-	●	●	-	-	1,0	1
170512PEFR-S	-	-	-	-	-	-	-	-	●	●	-	-	1,2	1
170516PEFR-S	-	-	-	-	-	-	-	-	●	●	-	-	1,6	1
170520PEFR-S	-	-	-	-	-	-	-	-	●	●	-	-	2,0	1
170524PEFR-S	-	-	-	-	-	-	-	-	●	●	-	-	2,4	1
170530PEFR-S	-	-	-	-	-	-	-	-	●	●	-	-	3,0	1
170532PEFR-S	-	-	-	-	-	-	-	-	●	●	-	-	3,2	1
170540PEFR-S	-	-	-	-	-	-	-	-	●	●	-	-	4,0	1
170550PEFR-S	-	-	-	-	-	-	-	-	●	●	-	-	5,0	2
170564PEFR-S	-	-	-	-	-	-	-	-	●	●	-	-	6,4	2

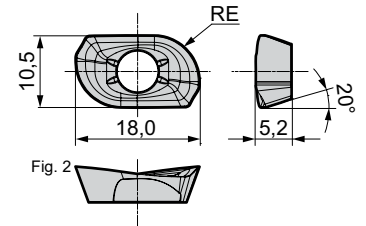
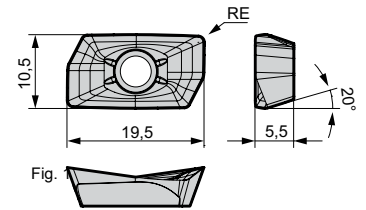

L: Low cutting force
 G: General purpose
 H: Strong edge
 F: Finishing
 P: High-precision machining
 S: Non ferrous metals

*P25 is applicable to cutter diameters Ø 25 mm and Ø 28 mm.
 *P32 is applicable to cutter diameters Ø 30 mm, Ø 32 mm and Ø 35 mm.

● = Euro stock
 ○ = Japan stock

□ = On request

□ = Not available



■ Features

● High-efficiency Shoulder Milling

Inserts for "WaveMill" WEZ type are arranged in multiple stages forming a long cutting edge, to enable high-efficiency shoulder milling of deep steps.

● Very Low Vibration Tendency

Sharp milling inserts and irregular pitched body help to reduce chatter marks caused by vibration.

● Support for all Types of Work Materials

A lineup of grades specific to each work materials, as well as the general-purpose ACU2500 grade, which is applicable to steel, stainless steel and cast iron.

■ Body Features

● Improved Flute Shape

Optimised, upward tapering chip pocket geometry for improved chip removal and increased rigidity of the cutter body.

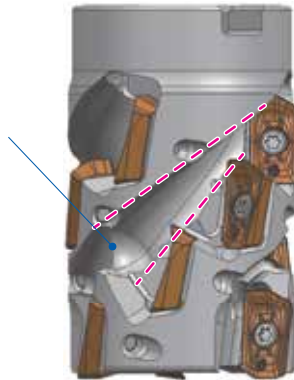

● Irregular Pitched Body

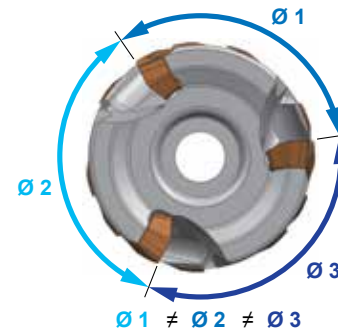

Irregular pitched body reduces vibration tendency

■ Cutting Performance

● Significantly less vibrations are a result of the combination of sharp inserts and irregular tooth pitch.

Capable of stable machining even with BT40 spindle machines

Vertical Machining Centre BT40

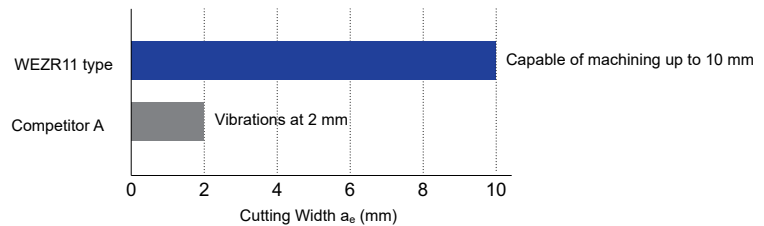

Machine: Vertical Machining Centre BT40,
Work Material: C55, overhang amount 60 mm
Tool: WEZR 11032E3632Z03 (Ø 32, 3 teeth, 4-stage)
Insert: AOET11T308PEER-G (ACU2500)
Cutting Conditions: $v_c = 150$ m/min, $f_z = 0,1$ mm/t, $a_p = 30$ mm, dry

Capable of stable machining even with a long overhang

Vertical Machining Centre BT50

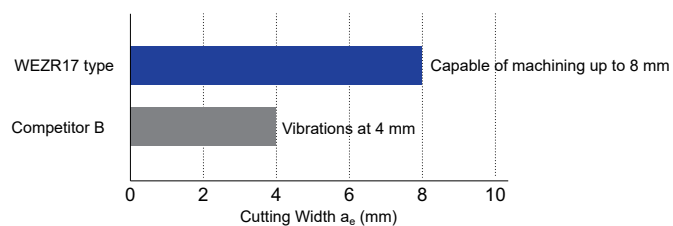
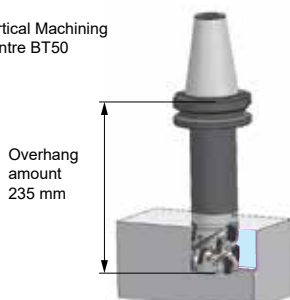

Machine: Vertical Machining Centre BT50,
Work Material: 42CrMo4
Tool: WEZR 17063RS5727Z04 (Ø 63, 4 teeth, 4-stage)
Insert: AOET170508PEER-G (ACU2500)
Cutting Conditions: $v_c = 150$ m/min, $f_z = 0,15$ mm/t, $a_p = 50$ mm, dry

Cutting Performance

- Optimised cutting edge shape and high-precision molding technology result in excellent shoulder accuracy.

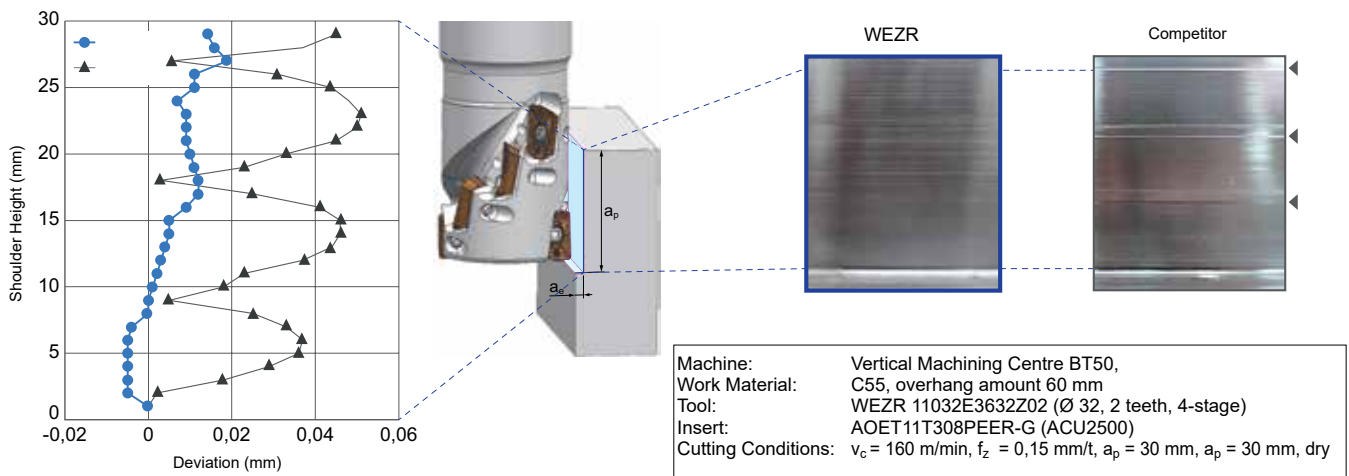

Application Range

- Steel, stainless steel, cast iron
- Aluminum alloys, titanium alloys

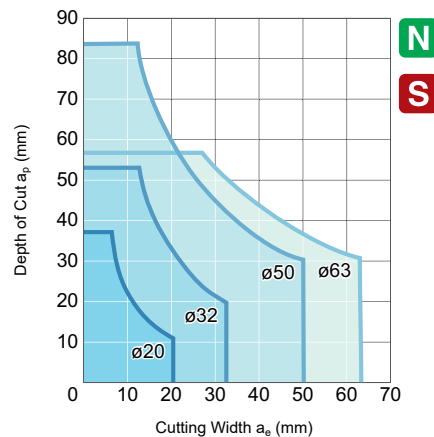
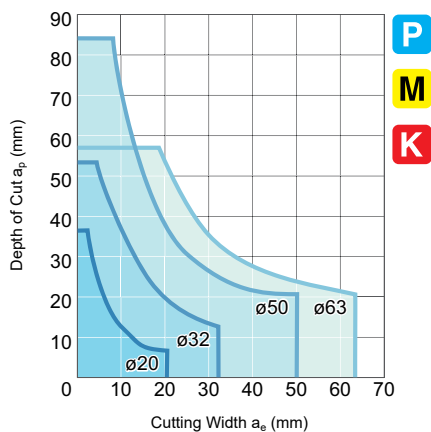

Note:

The depth of cut figures above are guidelines for use with BT50 machine tools. Use a depth of cut of approximately 50% if using BT40.

For a tool overhang of $L/D = 3$ or $L/D = 4$, use a depth of cut of approximately 50% or 25%, respectively.

There may be cases where machining cannot be performed at the depth of cut figures above, depending on the machine rigidity and work rigidity.

Cutting speed and feed rate data you will find on the next pages.

"WaveMill" Series WEZR 11000 RS

Repeater

Rake Angle	Radial	-11° - -9°	44-53 mm	90°
	Axial	14° - 15°		

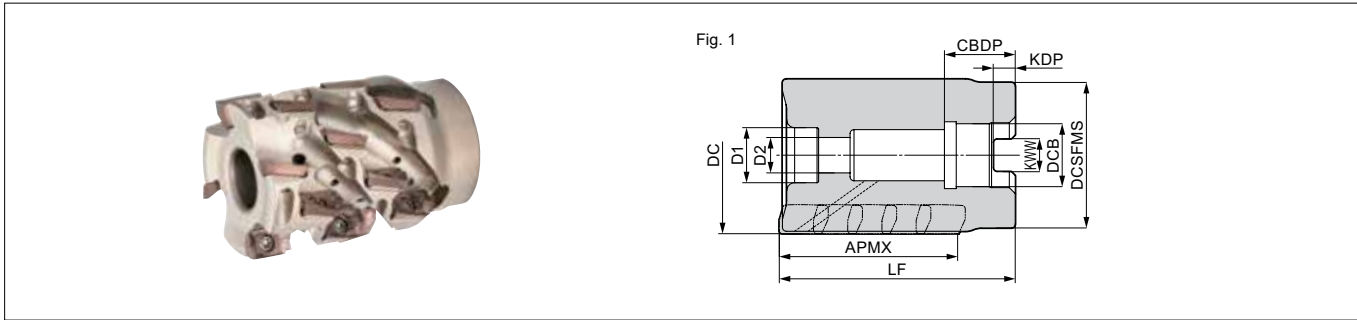

Body - WEZR (Shell Type)

Dimensions (mm)

Cat. No.		Stock	DC	APMX	DCSFMS	LF	DCB	KWW	KDP	CDBP	D1	D2	Total No. of Teeth	Steps	Effective No. of Teeth	Weight (kg)	Fig.
Metric	WEZR 11040RS4416Z04	○	40	44	37	60	16	8,4	5,6	18	14	9	20	5	4	0,27	1
	11050RS5322Z04	○	50	53	47	70	22	10,4	6,3	20	18	11	24	6	4	0,57	1

Take note of the cutter mounting size (DCB) when selecting a cutter. Inserts are sold separately.

Spare Parts

Applicable Cutters	Insert Screw		Wrench	Bolt
	WEZR 11040RS4416Z04 11050RS5322Z04			
	BFTX0306IP	1,5	TRDR08IP	BX0850 BX1060

Identification Details

WEZR 11 040 R S 44 16 Z04

Cutter Series	Insert Size	Cutter Diameter	Feed Direction	Metric	Max. Depth of Cut	Mounting Hole Diameter	Effective Number of Teeth
WEZR 11	040	R	S	44	16	Z04	

Recommended Cutting Conditions

ISO	Work Material	Hardness (HB)	Chip Breaker	Cutting Speed v_c (m/min)	Feed Rate f_z (mm/t)	Grades
P	Carbon Steel	≤ 280HB	G	100-150-200	0,08-0,12-0,20	ACU2500 XCU2500 ACP2000 ACP3000
	Alloy Steel	> 280HB	G	80-100-120	0,08-0,12-0,20	
M	Stainless Steel	≤ 280HB	G	80-120-160	0,08-0,12-0,20	ACU2500 ACM200 ACM300
K	Cast Iron Ductile Cast Iron	-	G	100-150-200	0,08-0,12-0,20	ACU2500 XCK2000 ACK2000 ACK3000
S	Exotic Alloy	-	G	40-50-60	0,08-0,12-0,20	ACU2500 ACM200 ACM300
N	Aluminum Alloy	Si ≤ 12,6%	S	300-500-800	0,05-0,10-0,15	DL2000 H20
		Si > 12,6%	S	100-200-250	0,05-0,10-0,15	

Min. - Optimum - Max.

Note:

The cutting conditions above are a guide. Actual conditions will need to be adjusted according to machine rigidity, work clamp rigidity, depth of cut and other factors.

There may be cases where machining cannot be performed under recommended cutting conditions, depending on the machine rigidity and work rigidity.

*When mounting inserts with nose radius of $\geq 2,4$ mm, modification of the body is required.



Modify this edge.

Reworking guidelines

Corner radius = 2,4 mm: C = 1 mm

(AOMT11T324PEER)

Corner radius = 3,0 mm: C = 1 mm

(AOMT11T330PEER)

Corner radius = 3,2 mm: C = 1 mm

(AOMT11T332PEER)

Standard: R = 1 mm

C: Chamfer

R: Radius

Inserts

Precautions for Mounting → P.9

Application	Coated Carbide								Carbide	DLC	Cermet	Dimensions (mm)		
High Speed / Light Cut														
General Purpose														
Roughing														
Cat. No.	ACU2500	XCU2500	ACP2000	ACP3000	XCK2000	ACK2000	ACK3000	ACM200	ACM300	H20	DL2000	T2500A	RE	Fig.
AOMT 11T302PEER-G	●		□	●		□	●	●	●	-	-	●	0,2	1
11T304PEER-G	●	○	●	●	○	●	●	●	●	-	-	●	0,4	1
11T305PEER-G	●		●	□		□	●	●	●	-	-	●	0,5	1
11T308PEER-G	●	○	●	●	○	●	●	●	●	-	-	●	0,8	1
11T310PEER-G	●		□	□		□	●	●	●	-	-	□	1,0	1
11T312PEER-G	●		□	●		□	●	●	●	-	-	□	1,2	1
11T316PEER-G	●		□	●		□	●	●	●	-	-		1,6	1
11T320PEER-G	●		□	●		□	●	●	●	-	-		2,0	1
11T324PEER-G	●		□	□		□	●	●	●	-	-		2,4	1
11T330PEER-G	●		□	●		□	●	●	●	-	-		3,0	2
11T332PEER-G	●		□	□		□	●	●	●	-	-		3,2	2
AOMT 11T304PEER-H	●	○	●	●	○	●	●	●	●	-	-	-	0,4	1
11T308PEER-H	●	○	●	●	○	●	●	●	●	-	-	-	0,8	1
11T312PEER-H	●		□	□		□	□	●	●	-	-	-	1,2	1
11T316PEER-H	●		□	□		□	□	●	●	-	-	-	1,6	1
AOET 11T302PEER-F	●		-			-				-	-	-	0,2	1
11T304PEER-F	●		-			-				-	-	-	0,4	1
11T305PEER-F	●		-			-				-	-	-	0,5	1
11T308PEER-F	●		-			-				-	-	-	0,8	1
11T310PEER-F	●		-			-				-	-	-	1,0	1
11T312PEER-F	●		-			-				-	-	-	1,2	1
11T316PEER-F	●		-			-				-	-	-	1,6	1
11T320PEER-F	●		-			-				-	-	-	2,0	1
11T324PEER-F	●		-			-				-	-	-	2,4	1
11T330PEER-F	●		-			-				-	-	-	3,0	2
11T332PEER-F	●		-			-				-	-	-	3,2	2
AOET 11T302PEFR-S	-	-	-	-	-	-	-	-	-	●	●	-	0,2	1
11T304PEFR-S	-	-	-	-	-	-	-	-	-	●	●	-	0,4	1
11T305PEFR-S	-	-	-	-	-	-	-	-	-	●	●	-	0,5	1
11T308PEFR-S	-	-	-	-	-	-	-	-	-	●	●	-	0,8	1
11T310PEFR-S	-	-	-	-	-	-	-	-	-	●	●	-	1,0	1
11T312PEFR-S	-	-	-	-	-	-	-	-	-	●	●	-	1,2	1
11T316PEFR-S	-	-	-	-	-	-	-	-	-	●	●	-	1,6	1
11T320PEFR-S	-	-	-	-	-	-	-	-	-	●	●	-	2,0	1
11T324PEFR-S	-	-	-	-	-	-	-	-	-	●	●	-	2,4	1
11T330PEFR-S	-	-	-	-	-	-	-	-	-	●	●	-	3,0	2
11T332PEFR-S	-	-	-	-	-	-	-	-	-	●	●	-	3,2	2

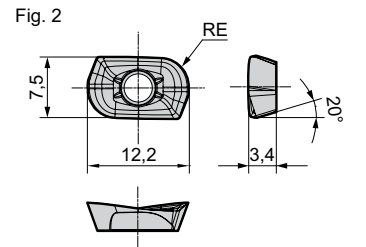
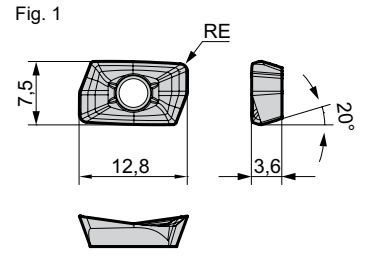

L: Low cutting force
 G: General purpose
 H: Strong edge
 F: Finishing
 P: High-precision machining
 S: Non ferrous metals

"WaveMill" Series WEZR 17000 RS

Repeater

Rake Angle	Radial	-8° - -6°	29-57 mm	90°
	Axial	7° - 15°		

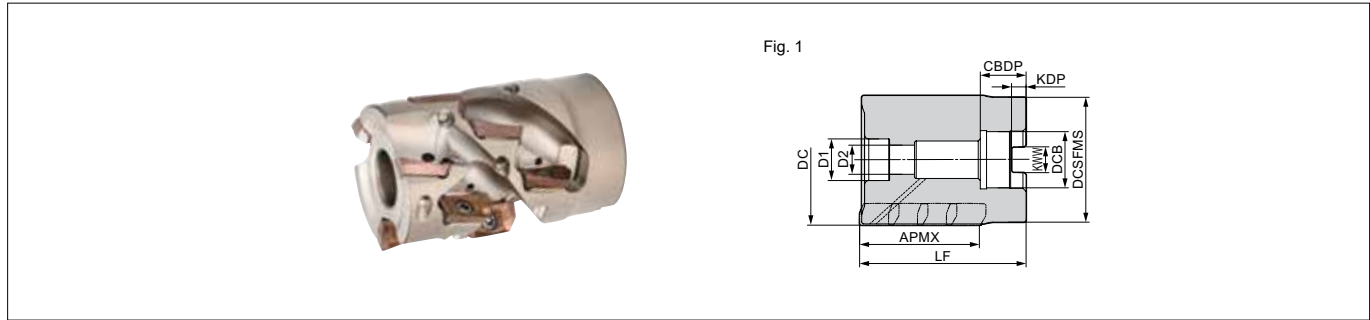

Body - WEZR (Shell Type)

Cat. No.		Stock	DC	APMX	DCSFMS	LF	DCB	KWW	KDP	CDBP	D1	D2	Total No. of Teeth	Steps	Effective No. of Teeth	Weight (kg)	Fig.
Metric	WEZR 17050RS2922Z04	○	40	29	47	50	22	10,4	6,3	20	18	11	8	2	4	0,35	1
	17050RS5722Z02	○	50	57	47	80	22	10,4	6,3	20	18	11	8	4	2	0,70	1
	17050RS5722Z03	○	50	57	47	80	22	10,4	6,3	20	18	11	12	4	3	0,59	1
	17063RS2927Z05	○	63	29	60	55	27	12,4	7	22	20	14	10	2	5	0,74	1
	17063RS5727Z03	○	63	57	60	80	27	12,4	7	22	20	14	12	4	3	1,11	1
	17063RS5727Z04	○	63	57	60	80	27	12,4	7	22	20	14	16	4	4	1,05	1
	17080RS5627Z05	○	80	56	70	80	27	12,4	7	22	20	14	20	4	5	1,85	1
	17080RS5632Z05	○	80	56	70	80	32	14,4	8	26	25	18	20	4	5	1,76	1

Take note of the cutter mounting size (DCB) when selecting a cutter. Inserts are sold separately.

Spare Parts

Applicable Cutters	Insert Screw		Wrench	Handle Grip	Wrench Bit	Bolt
		(N·m)				
WEZR 17050RS2922Z04	BFTX0409IP	3,0	-	HPS1015	TRB15IP	BX1045
17050RS5722Z02						BX1070
17050RS5722Z03						BX1240
17063RS2927Z05						BX1265
17063RS5727Z03						BX1265
17063RS5727Z04						BX1265
17080RS5627Z05						BX1660
17080RS5632Z05						BX1660

Identification Details

WEZR 17 050 R S 29 22 Z04

Cutter Series	Insert Size	Cutter Diameter	Feed Direction	Metric	Max. Depth of Cut	Mounting Hole Diameter	Effective Number of Teeth
WEZR	17	050	R	S	29	22	Z04

Recommended Cutting Conditions

ISO	Work Material	Hardness (HB)	Chip breaker	Cutting Speed v_c (m/min)	Feed Rate f_z (mm/t)	Grades
P	Carbon Steel	≤ 280HB	G	100-150-200	0,10-0,20-0,30	ACU2500 XCU2500 ACP2000 ACP3000
	Alloy Steel	> 280HB	G	80-100-120	0,10-0,20-0,30	
M	Stainless Steel	≤ 280HB	G	100-150-80	0,10-0,20-0,30	ACU2500 ACM200 ACM300
K	Cast Iron Ductile Cast Iron	-	G	100-150-200	0,10-0,20-0,30	ACU2500 XCK2000 ACK2000 ACK3000
S	Exotic Alloy	-	G	40-50-60	0,10-0,20-0,30	ACU2500 ACM200 ACM300
N	Aluminum Alloy	Si ≤ 12,6%	S	300-500-800	0,05-0,10-0,15	DL2000 H20
		Si > 12,6%	S	100-200-250	0,05-0,10-0,15	

Min. - Optimum - Max.

Note:

The cutting conditions above are a guide. Actual conditions will need to be adjusted according to machine rigidity, work clamp rigidity, depth of cut and other factors. There may be cases where machining cannot be performed under recommended cutting conditions, depending on the machine rigidity and work rigidity.

*When mounting inserts with nose radius of ≥ 2,4 mm, modification of the body is required.



Modify this edge.

Reworking guidelines

- Corner radius = 2,4 mm: C = 1 mm (AOMT170524PEER)
- Corner radius = 3,0 mm: C = 1 mm (AOMT170530PEER)
- Corner radius = 3,2 mm: C = 1 mm (AOMT170532PEER)
- Corner radius = 4,0 mm: C = 2 mm (AOMT170540PEER)
- Corner radius = 5,0 mm: C = 5 mm (AOMT170550PEER)
- Corner radius = 6,4 mm: C = 5 mm (AOMT170564PEER)
- Standard: R = 1 mm
- C: Chamfer
- R: Radius

"Wave Mill" Series WEZR 17000 RS

Inserts

Precautions for Mounting

→ P.9

Dimensions (mm)

Application	Coated Carbide								Carbide	DLC	Cermel	RE	Fig.
	P	P	P	K	K	MS	MS	N					
High Speed / Light Cut													
General Purpose													
Roughing													
Cat. No.	ACU2500	XCU2500	ACP2000	ACP3000	XCK2000	ACK2000	ACK3000	ACM200	ACM300	H20	DL2000	T2500A	
AOMT 170502PEER-L	●			□			□	●	●			□	0,2 1
170504PEER-L	●	○		●	○		●	●	●			●	0,4 1
170508PEER-L	●	○		●	○		●	●	●			●	0,8 1
170512PEER-L	●			□			□	●	●				1,2 1
170516PEER-L	●			□			□	●	●				1,6 1
AOMT 170502PEER-G	●		□	●		□	●	●	●			□	0,2 1
170504PEER-G	●	○	●	●	○	●	●	●	●			●	0,4 1
170505PEER-G	●		□	□		□	□	●	●			□	0,5 1
170508PEER-G	●	○	●	●	○	●	●	●	●			●	0,8 1
170510PEER-G	●		□	□		□	□	●	●			□	1,0 1
170512PEER-G	●		□	●		□	●	●	●			□	1,2 1
170516PEER-G	●		□	●		□	●	●	●				1,6 1
170520PEER-G	●		□	●		□	●	●	●				2,0 1
170524PEER-G	●		□	□		□	□	●	●				2,4 1
170530PEER-G	●		□	●		□	●	●	●				3,0 1
170532PEER-G	●		□	□		□	●	●	●				3,2 1
170540PEER-G	●		□	●		□	●	●	●				4,0 1
170550PEER-G	●		□	●		□	●	●	●				5,0 2
170564PEER-G	●		□	□		□	□	●	●				6,4 2
AOMT 170504PEER-H	●	○	●	●	○	●	●	●	●				0,4 1
170508PEER-H	●	○	●	●	○	●	●	●	●				0,8 1
170512PEER-H	●		□	□		□	□	●	●				1,2 1
170516PEER-H	●		□	●		□	□	●	●				1,6 1
AOET 170502PEER-F	●												0,2 1
170504PEER-F	●												0,4 1
170505PEER-F	●												0,5 1
170508PEER-F	●												0,8 1
170510PEER-F	●												1,0 1
170512PEER-F	●												1,2 1
170516PEER-F	●												1,6 1
170520PEER-F	●												2,0 1
170524PEER-F	●												2,4 1
170530PEER-F	●												3,0 1
170532PEER-F	●												3,2 1
170540PEER-F	●												4,0 1
170550PEER-F	●												5,0 2
170564PEER-F	●												6,4 2
AOET 170502PEFR-S	-	-	-	-	-	-	-	-	●	●	-	-	0,2 1
170504PEFR-S	-	-	-	-	-	-	-	-	●	●	-	-	0,4 1
170505PEFR-S	-	-	-	-	-	-	-	-	●	●	-	-	0,5 1
170508PEFR-S	-	-	-	-	-	-	-	-	●	●	-	-	0,8 1
170510PEFR-S	-	-	-	-	-	-	-	-	●	●	-	-	1,0 1
170512PEFR-S	-	-	-	-	-	-	-	-	●	●	-	-	1,2 1
170516PEFR-S	-	-	-	-	-	-	-	-	●	●	-	-	1,6 1
170520PEFR-S	-	-	-	-	-	-	-	-	●	●	-	-	2,0 1
170524PEFR-S	-	-	-	-	-	-	-	-	●	●	-	-	2,4 1
170530PEFR-S	-	-	-	-	-	-	-	-	●	●	-	-	3,0 1
170532PEFR-S	-	-	-	-	-	-	-	-	●	●	-	-	3,2 1
170540PEFR-S	-	-	-	-	-	-	-	-	●	●	-	-	4,0 1
170550PEFR-S	-	-	-	-	-	-	-	-	●	●	-	-	5,0 2
170564PEFR-S	-	-	-	-	-	-	-	-	●	●	-	-	6,4 2

Fig. 1

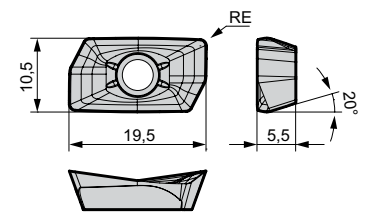
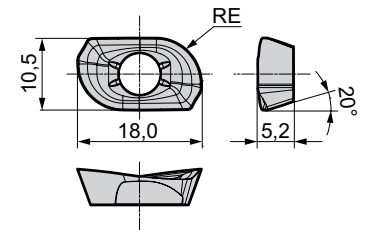

Fig. 2



L: Low cutting force
G: General purpose
H: Strong edge
F: Finishing
P: High-precision machining
S: Non ferrous metals

"WaveMill" Series WEZR 11000 E

Repeater

Rake Angle	Radial	-15° - -11°	19-61 mm	90°
	Axial	8° - 14°		

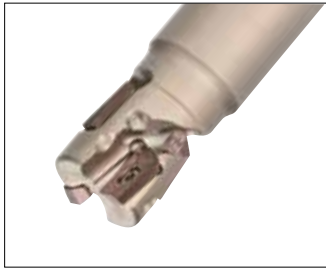

Fig. 1

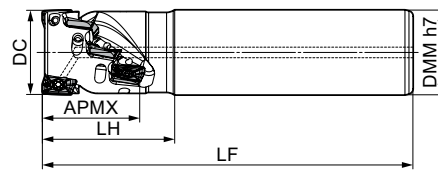
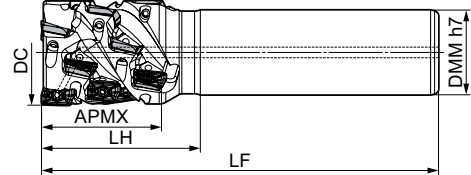

Fig. 2





Body - WEZR (Shank Type)

Dimensions (mm)

Cat. No.	Stock	DC	APMX	DMM	LH	LF	Total No. of Teeth	Steps	Effective No. of Teeth	Weight (kg)	Fig.
WEZR 11020E1920Z02	○	20	19	20	30	110	4	2	2	0,22	1
11020E3620Z01	○	20	36	20	45	125	4	4	1	0,24	1
11025E2725Z02	○	25	27	25	40	130	6	3	2	0,41	1
11025E3625Z02	○	25	36	25	50	140	8	4	2	0,42	1
11030E5325Z02	○	30	53	25	65	155	12	6	2	0,52	2
11032E3632Z02	○	32	36	32	50	140	8	4	2	0,74	1
11032E3632Z03	○	32	36	32	50	140	12	4	3	0,71	1
11032E5332Z02	○	32	53	32	70	160	12	6	2	0,90	1
11035E5332Z03	○	35	53	32	65	155	18	6	3	0,88	2
11040E4432Z03	○	40	44	32	60	150	15	5	3	0,87	2
11040E4432Z04	○	40	44	32	60	150	20	5	4	0,85	2
11040E6132Z03	○	40	61	32	75	165	21	7	3	0,95	2

Inserts are sold separately.

Spare Parts

Applicable Cutters	Insert Screw		Wrench
			
WEZR 11_ _ _	BFTX0306IP	1,5	TRDR08IP

Recommended Cutting Conditions

ISO	Work Material	Hardness (HB)	Chip breaker	Cutting Speed v _c (m/min)	Feed Rate f _z (mm/t)	Grades
P	Carbon Steel	≤ 280HB	G	100-150-200	0,08-0,12-0,20	ACU2500 XCU2500
		> 280HB	G	80-100-120	0,08-0,12-0,20	ACP2000 ACP3000
	Alloy Steel	≤ 280HB	G	100-150-80	0,08-0,12-0,20	
M	Stainless Steel	≤ 280HB	G	80-120-160	0,08-0,12-0,20	ACU2500 ACM200 ACM300
K	Cast Iron Ductile Cast Iron	-	G	100-150-200	0,08-0,12-0,20	ACU2500 XCK2000 ACK2000 ACK3000
S	Exotic Alloy	-	G	40-50-60	0,08-0,12-0,20	ACU2500 ACM200 ACM300
N	Aluminum Alloy	Si ≤ 12,6%	S	300-500-800	0,05-0,10-0,15	DL2000
		Si > 12,6%	S	100-200-250	0,05-0,10-0,15	H20

Min. - Optimum - Max.

Note:

The cutting conditions above are a guide. Actual conditions will need to be adjusted according to machine rigidity, work clamp rigidity, depth of cut and other factors. There may be cases where machining cannot be performed under recommended cutting conditions, depending on the machine rigidity and work rigidity.

Identification Details

WEZR 11 032 E 36 32 Z02

Cutter Series	Insert Size	Cutter Diameter	Shank Type	Max. Depth of Cut	Shank Diameter	Effective Number of Teeth
WEZR 11	032	E	36	32	Z02	

*When mounting inserts with nose radius of ≥ 2,4 mm, modification of the body is required.



Modify this edge.

Reworking guidelines

Corner radius = 2,4 mm: C = 1 mm

(AOMT11T324PEER)

Corner radius = 3,0 mm: C = 1 mm

(AOMT11T330PEER)

Corner radius = 3,2 mm: C = 1 mm

(AOMT11T332PEER)

Standard: R = 1 mm

C: Chamfer

R: Radius

Inserts

Precautions for Mounting → P. 9

Application	Coated Carbide								Carbide	DLC	Cermets	Dimensions (mm)		
	ACU2500	XCU2500	ACP2000	ACP3000	XCK2000	ACK2000	ACK3000	ACM200						ACM300
High Speed / Light Cut														
General Purpose														
Roughing														
Cat. No.	ACU2500	XCU2500	ACP2000	ACP3000	XCK2000	ACK2000	ACK3000	ACM200	ACM300	H20	DL2000	T2500A	RE	Fig.
AOMT 11T302PEER-G	●		□	●	○	□	●	●	●	-	-	-	●	0,2 1
11T304PEER-G	●	○	□	●	○	□	●	●	●	-	-	-	●	0,4 1
11T305PEER-G	●		□	□		□	□	●	●	-	-	-	□	0,5 1
11T308PEER-G	●	○	●	●	○	●	●	●	●	-	-	-	●	0,8 1
11T310PEER-G	●		□	□		□	□	●	●	-	-	-	□	1,0 1
11T312PEER-G	●		□	●		□	●	●	●	-	-	-	□	1,2 1
11T316PEER-G	●		□	●		□	●	●	●	-	-	-		1,6 1
11T320PEER-G	●		□	●		□	●	●	●	-	-	-		2,0 1
11T324PEER-G	●		□	□		□	●	●	●	-	-	-		2,4 1
11T330PEER-G	●		□	●		□	●	●	●	-	-	-		3,0 2
11T332PEER-G	●		□	□		□	□	●	●	-	-	-		3,2 2
AOMT 11T304PEER-H	●	○	●	●	○	●	●	●	●	-	-	-	-	0,4 1
11T308PEER-H	●	○	●	●	○	●	●	●	●	-	-	-	-	0,8 1
11T312PEER-H	●		□	□		□	□	●	●	-	-	-	-	1,2 1
11T316PEER-H	●		□	□		□	□	●	●	-	-	-	-	1,6 1
AOET 11T302PEER-F	●		-			-		-	-	-	-	-	-	0,2 1
11T304PEER-F	●		-			-		-	-	-	-	-	-	0,4 1
11T305PEER-F	●		-			-		-	-	-	-	-	-	0,5 1
11T308PEER-F	●		-			-		-	-	-	-	-	-	0,8 1
11T310PEER-F	●		-			-		-	-	-	-	-	-	1,0 1
11T312PEER-F	●		-			-		-	-	-	-	-	-	1,2 1
11T316PEER-F	●		-			-		-	-	-	-	-	-	1,6 1
11T320PEER-F	●		-			-		-	-	-	-	-	-	2,0 1
11T324PEER-F	●		-			-		-	-	-	-	-	-	2,4 1
11T330PEER-F	●		-			-		-	-	-	-	-	-	3,0 2
11T332PEER-F	●		-			-		-	-	-	-	-	-	3,2 2
AOET 11T302PEER-P20	●		-			-		-	-	-	-	-	-	0,2 1
11T304PEER-P20	●		-			-		-	-	-	-	-	-	0,4 1
11T305PEER-P20	●		-			-		-	-	-	-	-	-	0,5 1
11T308PEER-P20	●		-			-		-	-	-	-	-	-	0,8 1
11T310PEER-P20	●		-			-		-	-	-	-	-	-	1,0 1
11T312PEER-P20	●		-			-		-	-	-	-	-	-	1,2 1
11T302PEER-P25	●		-			-		-	-	-	-	-	-	0,2 1
11T304PEER-P25	●		-			-		-	-	-	-	-	-	0,4 1
11T305PEER-P25	●		-			-		-	-	-	-	-	-	0,5 1
11T308PEER-P25	●		-			-		-	-	-	-	-	-	0,8 1
11T310PEER-P25	●		-			-		-	-	-	-	-	-	1,0 1
11T312PEER-P25	●		-			-		-	-	-	-	-	-	1,2 1
AOET 11T302PEFR-S	-	-	-	-	-	-	-	-	-	●	●	-	-	0,2 1
11T304PEFR-S	-	-	-	-	-	-	-	-	-	●	●	-	-	0,4 1
11T305PEFR-S	-	-	-	-	-	-	-	-	-	●	●	-	-	0,5 1
11T308PEFR-S	-	-	-	-	-	-	-	-	-	●	●	-	-	0,8 1
11T310PEFR-S	-	-	-	-	-	-	-	-	-	●	●	-	-	1,0 1
11T312PEFR-S	-	-	-	-	-	-	-	-	-	●	●	-	-	1,2 1
11T316PEFR-S	-	-	-	-	-	-	-	-	-	●	●	-	-	1,6 1
11T320PEFR-S	-	-	-	-	-	-	-	-	-	●	●	-	-	2,0 1
11T324PEFR-S	-	-	-	-	-	-	-	-	-	●	●	-	-	2,4 1
11T330PEFR-S	-	-	-	-	-	-	-	-	-	●	●	-	-	3,0 2
11T332PEFR-S	-	-	-	-	-	-	-	-	-	●	●	-	-	3,2 2

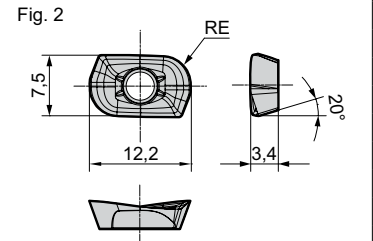
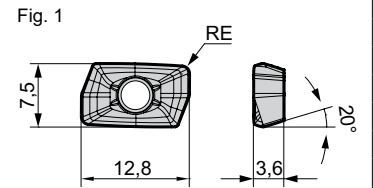

L: Low cutting force
G: General purpose
H: Strong edge
F: Finishing
P: High-precision machining
S: Non ferrous metals

*P20 is applicable to cutter diameters \varnothing 18 mm, \varnothing 20 mm.
*P25 is applicable to cutter diameters \varnothing 25 mm, \varnothing 28 mm.

Use peripheral inserts with RE \leq 0,8 mm from the second step and above.

"WaveMill" Series WEZR 17000 E

Repeater

Rake Angle	Radial	-9° - -8°	29-84 mm	90°
	Axial	10° - 12°		

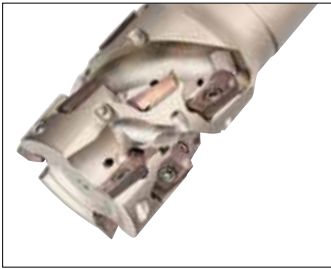
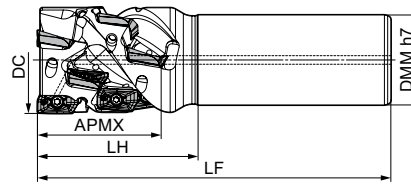

Fig. 1





Body - WEZR (Shank Type)

Dimensions (mm)

Cat. No.	Stock	DC	APMX	DMM	LH	LF	Total No. of Teeth	Steps	Effective No. of Teeth	Weight (kg)	Fig.
WEZR 17040E2932Z03	○	40	29	32	45	110	6	3	2	0,75	1
17040E4332Z02	○	40	43	32	60	125	6	2	3	0,86	1
17050E5742Z03	○	50	57	42	75	130	12	3	4	1,58	1
17050E8442Z02	○	50	84	42	105	140	12	2	6	1,04	1

Inserts are sold separately.

Spare Parts

Applicable Cutters	Insert Screw		Wrench
			
WEZR 17_ _ _	BFTX0409IP	3,0	TRDR15IP

Identification Details

WEZR 17 040 E 29 32 Z03

Cutter Series	Insert Size	Cutter Diameter	Shank Type	Max. Depth of Cut	Shank Diameter	Effective Number of Teeth
WEZR	17	040	E	29	32	Z03

Recommended Cutting Conditions

ISO	Work Material	Hardness (HB)	Chip-breaker	Cutting Speed v_c (m/min)	Feed Rate f_z (mm/t)	Grades
P	Carbon Steel	≤ 280HB	G	100-150-200	0,10-0,20-0,30	ACU2500 XCU2500
		> 280HB	G	80-100-120	0,10-0,20-0,30	ACP2000
	Alloy Steel	≤ 280HB	G	100-150-80	0,10-0,20-0,30	ACP3000
M	Stainless Steel	≤ 280HB	G	80-120-160	0,10-0,20-0,30	ACU2500 ACM200 ACM300
K	Cast Iron Ductile Cast Iron	-	G	100-150-200	0,10-0,20-0,30	ACU2500 XCK2000 ACK2000 ACK3000
		-	G	40-50-60	0,10-0,20-0,30	ACU2500 ACM200 ACM300
S	Exotic Alloy	-	G	40-50-60	0,10-0,20-0,30	ACU2500 ACM200 ACM300
N	Aluminum Alloy	Si ≤ 12,6%	S	300-500-800	0,05-0,10-0,15	DL2000
		Si > 12,6%	S	100-200-250	0,05-0,10-0,15	H20

Min. - Optimum - Max.

Note:

The cutting conditions above are a guide. Actual conditions will need to be adjusted according to machine rigidity, work clamp rigidity, depth of cut and other factors.

There may be cases where machining cannot be performed under recommended cutting conditions, depending on the machine rigidity and work rigidity.

*When mounting inserts with nose radius of $\geq 2,4$ mm, modification of the body is required.



Modify this edge.

Reworking guidelines
 Corner radius = 2,4 mm: C = 1 mm (AOMT170524PEER)
 Corner radius = 3,0 mm: C = 1 mm (AOMT170530PEER)
 Corner radius = 3,2 mm: C = 1 mm (AOMT170532PEER)
 Corner radius = 4,0 mm: C = 2 mm (AOMT170540PEER)
 Corner radius = 5,0 mm: C = 5 mm (AOMT170550PEER)
 Corner radius = 6,4 mm: C = 5 mm (AOMT170564PEER)
 Standard: R = 1 mm

C: Chamfer
 R: Radius

Inserts

Precautions for Mounting

→ P. 9

Application	Coated Carbide										Carbide	DLC	Cemet	RE	Fig.
	ACU2500	XCU2500	ACP2000	ACP3000	XCK2000	ACK2000	ACK3000	ACM200	ACM300	H20					
High Speed / Light Cut	●	●	●	●	●	●	●	●	●	●	●	●	●	●	●
General Purpose	●	●	●	●	●	●	●	●	●	●	●	●	●	●	●
Roughing	●	●	●	●	●	●	●	●	●	●	●	●	●	●	●
Cat. No.	ACU2500	XCU2500	ACP2000	ACP3000	XCK2000	ACK2000	ACK3000	ACM200	ACM300	H20	DL2000	T2500A	RE	Fig.	
AOMT 170502PEER-L	●	○	-	□	○	-	□	●	●	-	-	-	□	0,2	1
170504PEER-L	●	○	-	●	○	-	●	●	●	-	-	-	●	0,4	1
170508PEER-L	●	○	-	●	○	-	●	●	●	-	-	-	●	0,8	1
170512PEER-L	●	-	-	□	-	-	□	●	●	-	-	-	-	1,2	1
170516PEER-L	●	-	-	□	-	-	□	●	●	-	-	-	-	1,6	1
AOMT 170502PEER-G	●	-	□	●	○	□	●	●	●	-	-	-	□	0,2	1
170504PEER-G	●	○	●	●	○	●	●	●	●	-	-	-	●	0,4	1
170505PEER-G	●	-	□	□	-	□	□	●	●	-	-	-	□	0,5	1
170508PEER-G	●	○	●	●	○	●	●	●	●	-	-	-	□	0,8	1
170510PEER-G	●	-	□	□	-	□	□	●	●	-	-	-	□	1,0	1
170512PEER-G	●	-	□	●	-	□	●	●	●	-	-	-	□	1,2	1
170516PEER-G	●	-	□	●	-	□	●	●	●	-	-	-	-	1,6	1
170520PEER-G	●	-	□	●	-	□	●	●	●	-	-	-	-	2,0	1
170524PEER-G	●	-	□	□	-	□	□	●	●	-	-	-	-	2,4	1
170530PEER-G	●	-	□	□	-	□	□	●	●	-	-	-	-	3,0	1
170532PEER-G	●	-	□	□	-	□	□	●	●	-	-	-	-	3,2	1
170540PEER-G	●	-	□	●	-	□	●	●	●	-	-	-	-	4,0	1
170550PEER-G	●	-	□	●	-	□	●	●	●	-	-	-	-	5,0	2
170564PEER-G	□	-	□	□	-	□	□	●	●	-	-	-	-	6,4	2
AOMT 170504PEER-H	●	○	●	●	○	●	●	●	●	-	-	-	-	0,4	1
170508PEER-H	●	○	●	●	○	●	●	●	●	-	-	-	-	0,8	1
170512PEER-H	●	-	□	□	-	□	□	●	●	-	-	-	-	1,2	1
170516PEER-H	●	-	□	●	-	□	□	●	●	-	-	-	-	1,6	1
AOET 170502PEER-F	●	-	-	-	-	-	-	-	-	-	-	-	-	0,2	1
170504PEER-F	●	-	-	-	-	-	-	-	-	-	-	-	-	0,4	1
170505PEER-F	●	-	-	-	-	-	-	-	-	-	-	-	-	0,5	1
170508PEER-F	●	-	-	-	-	-	-	-	-	-	-	-	-	0,8	1
170510PEER-F	●	-	-	-	-	-	-	-	-	-	-	-	-	1,0	1
170512PEER-F	●	-	-	-	-	-	-	-	-	-	-	-	-	1,2	1
170516PEER-F	●	-	-	-	-	-	-	-	-	-	-	-	-	1,6	1
170520PEER-F	●	-	-	-	-	-	-	-	-	-	-	-	-	2,0	1
170524PEER-F	●	-	-	-	-	-	-	-	-	-	-	-	-	2,4	1
170530PEER-F	●	-	-	-	-	-	-	-	-	-	-	-	-	3,0	1
170532PEER-F	●	-	-	-	-	-	-	-	-	-	-	-	-	3,2	1
170540PEER-F	●	-	-	-	-	-	-	-	-	-	-	-	-	4,0	1
170550PEER-F	●	-	-	-	-	-	-	-	-	-	-	-	-	5,0	2
170564PEER-F	●	-	-	-	-	-	-	-	-	-	-	-	-	6,4	2
AOET 170502PEFR-S	-	-	-	-	-	-	-	-	-	●	●	-	-	0,2	1
170504PEFR-S	-	-	-	-	-	-	-	-	-	●	●	-	-	0,4	1
170505PEFR-S	-	-	-	-	-	-	-	-	-	●	●	-	-	0,5	1
170508PEFR-S	-	-	-	-	-	-	-	-	-	●	●	-	-	0,8	1
170510PEFR-S	-	-	-	-	-	-	-	-	-	●	●	-	-	1,0	1
170512PEFR-S	-	-	-	-	-	-	-	-	-	●	●	-	-	1,2	1
170516PEFR-S	-	-	-	-	-	-	-	-	-	●	●	-	-	1,6	1
170520PEFR-S	-	-	-	-	-	-	-	-	-	●	●	-	-	2,0	1
170524PEFR-S	-	-	-	-	-	-	-	-	-	●	●	-	-	2,4	1
170530PEFR-S	-	-	-	-	-	-	-	-	-	●	●	-	-	3,0	1
170532PEFR-S	-	-	-	-	-	-	-	-	-	●	●	-	-	3,2	1
170540PEFR-S	-	-	-	-	-	-	-	-	-	●	●	-	-	4,0	1
170550PEFR-S	-	-	-	-	-	-	-	-	-	●	●	-	-	5,0	2
170564PEFR-S	-	-	-	-	-	-	-	-	-	●	●	-	-	6,4	2

Dimensions (mm)

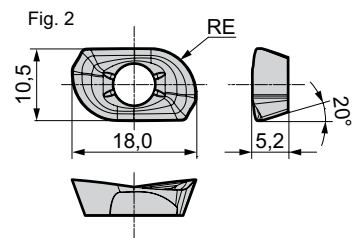
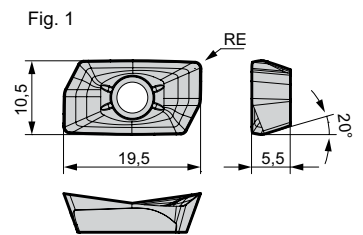

L: Low cutting force
G: General purpose
H: Strong edge
F: Finishing
P: High-precision machining
S: Non ferrous metals

Use peripheral inserts with RE ≤ 0,8 mm from the second step and above.

Rake Angle	Radial	-7° -- -18°	10 mm	90°
	Axial	6° -- 15°		



Fig. 1

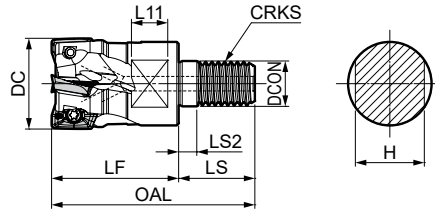

Head

Dimensions (mm)

Cat. No.	Stock	DC	DCON	CRKS	OAL	LF	LS2	L11	H	No. of Teeth	Weight (kg)	Fig.
WEZ 11016M08Z2	●	16	8,5	M8	42	25	5	8	13	2	0,03	1
11018M08Z2	●	18	8,5	M8	42	25	5	8	13	2	0,03	1
11020M10Z2	●	20	10,5	M10	49	30	5	8	15	2	0,06	1
11020M10Z3	●	20	10,5	M10	49	30	5	8	15	3	0,05	1
11022M10Z3	●	22	10,5	M10	49	30	5	8	15	3	0,06	1
11025M12Z2	●	25	12,5	M12	56	35	5	10	19	2	0,11	1
11025M12Z3	●	25	12,5	M12	56	35	5	10	19	3	0,10	1
11025M12Z4	●	25	12,5	M12	56	35	5	10	19	4	0,10	1
11026M12Z4	●	26	12,5	M12	56	35	5	10	19	4	0,10	1
11026M12Z5	●	26	12,5	M12	56	35	5	10	19	5	0,09	1
11028M12Z4	●	28	12,5	M12	56	35	5	10	19	4	0,11	1
11028M12Z5	●	28	12,5	M12	56	35	5	10	19	5	0,10	1
11030M16Z2	●	30	17	M16	63	40	5	10	24	2	0,20	1
11030M16Z4	●	30	17	M16	63	40	5	10	24	4	0,19	1
11030M16Z5	●	30	17	M16	63	40	5	10	24	5	0,17	1
11032M16Z2	●	32	17	M16	63	40	5	10	24	2	0,22	1
11032M16Z3	●	32	17	M16	63	40	5	10	24	3	0,20	1
11032M16Z4	●	32	17	M16	63	40	5	10	24	4	0,20	1
11032M16Z5	●	32	17	M16	63	40	5	10	24	5	0,19	1
11035M16Z2	●	35	17	M16	63	40	5	10	24	2	0,24	1
11035M16Z5	●	35	17	M16	63	40	5	10	24	5	0,22	1
11040M16Z2	●	40	17	M16	63	40	5	10	24	2	0,28	1
11040M16Z4	●	40	17	M16	63	40	5	10	24	4	0,26	1
11040M16Z5	●	40	17	M16	63	40	5	10	24	5	0,26	1
11040M16Z6	●	40	17	M16	63	40	5	10	24	6	0,25	1

Inserts are sold separately. Arbor see P4

Spare Parts

Applicable Cutters	Insert Screw		Wrench
	WEZ 11016M08Z2 11018M08Z2 11020M10Z2-11040M16Z2	BFTX0305IP BFTX0306IP	1,5 (N·m)

Recommended Cutting Conditions

→ P. 8

Identification Details

WEZ	11	016	M 08	Z2
Cutter Series	Insert Size	Cutter Diameter	Mounting Screw Size	Number of Teeth

*When mounting inserts with nose radius of $\geq 2,4$ mm, modification of the body is required.

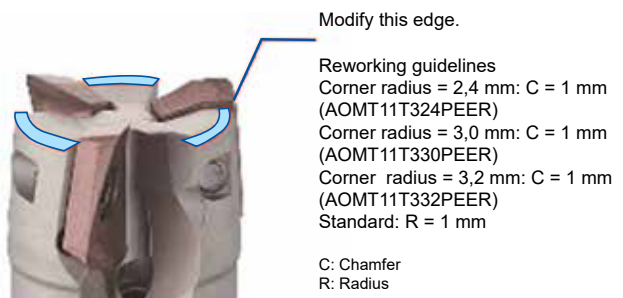

Inserts

Precautions for Mounting → P. 9

Application	Coated Carbide								Carbide	DLC	Cermets	Dimensions (mm)		
	K	P	P	K	K	MS	MS	N						
High Speed / Light Cut														
General Purpose														
Roughing														
Cat. No.	ACU2500	XCU2500	ACP2000	ACP3000	XCK2000	ACK2000	ACK3000	ACM200	ACM300	H20	DL2000	T2500A	RE	Fig.
AOMT 11T302PEER-G	●		□	●		□	●	●	●	-	-	●	0,2	1
11T304PEER-G	●	○	●	●	○	●	●	●	●	-	-	●	0,4	1
11T305PEER-G	●		●	□		□	●	●	●	-	-	□	0,5	1
11T308PEER-G	●	○	●	●	○	●	●	●	●	-	-	●	0,8	1
11T310PEER-G	●		□	□		□	●	●	●	-	-	□	1,0	1
11T312PEER-G	●		□	●		□	●	●	●	-	-	□	1,2	1
11T316PEER-G	●		□	●		□	●	●	●	-	-		1,6	1
11T320PEER-G	●		□	●		□	●	●	●	-	-		2,0	1
11T324PEER-G	●		□	□		□	●	●	●	-	-		2,4	1
11T330PEER-G	●		□	●		□	●	●	●	-	-		3,0	2
11T332PEER-G	●		□	□		□	●	●	●	-	-		3,2	2
AOMT 11T304PEER-H	●	○	●	●	○	●	●	●	●	-	-	-	0,4	1
11T308PEER-H	●	○	●	●	○	●	●	●	●	-	-	-	0,8	1
11T312PEER-H	●		□	□		□	●	●	●	-	-	-	1,2	1
11T316PEER-H	●		□	□		□	●	●	●	-	-	-	1,6	1
AOET 11T302PEER-F	●		-			-	-	-	-	-	-	-	0,2	1
11T304PEER-F	●		-			-	-	-	-	-	-	-	0,4	1
11T305PEER-F	●		-			-	-	-	-	-	-	-	0,5	1
11T308PEER-F	●		-			-	-	-	-	-	-	-	0,8	1
11T310PEER-F	●		-			-	-	-	-	-	-	-	1,0	1
11T312PEER-F	●		-			-	-	-	-	-	-	-	1,2	1
11T316PEER-F	●		-			-	-	-	-	-	-	-	1,6	1
11T320PEER-F	●		-			-	-	-	-	-	-	-	2,0	1
11T324PEER-F	●		-			-	-	-	-	-	-	-	2,4	1
11T330PEER-F	●		-			-	-	-	-	-	-	-	3,0	2
11T332PEER-F	●		-			-	-	-	-	-	-	-	3,2	2
AOET 11T302PEER-P16	●		-			-	-	-	-	-	-	-	0,2	1
11T304PEER-P16	●		-			-	-	-	-	-	-	-	0,4	1
11T305PEER-P16	●		-			-	-	-	-	-	-	-	0,5	1
11T308PEER-P16	●		-			-	-	-	-	-	-	-	0,8	1
11T310PEER-P16	●		-			-	-	-	-	-	-	-	1,0	1
11T312PEER-P16	●		-			-	-	-	-	-	-	-	1,2	1
11T302PEER-P20	●		-			-	-	-	-	-	-	-	0,2	1
11T304PEER-P20	●		-			-	-	-	-	-	-	-	0,4	1
11T305PEER-P20	●		-			-	-	-	-	-	-	-	0,5	1
11T308PEER-P20	●		-			-	-	-	-	-	-	-	0,8	1
11T310PEER-P20	●		-			-	-	-	-	-	-	-	1,0	1
11T312PEER-P20	●		-			-	-	-	-	-	-	-	1,2	1
11T302PEER-P25	●		-			-	-	-	-	-	-	-	0,2	1
11T304PEER-P25	●		-			-	-	-	-	-	-	-	0,4	1
11T305PEER-P25	●		-			-	-	-	-	-	-	-	0,5	1
11T308PEER-P25	●		-			-	-	-	-	-	-	-	0,8	1
11T310PEER-P25	●		-			-	-	-	-	-	-	-	1,0	1
11T312PEER-P25	●		-			-	-	-	-	-	-	-	1,2	1
AOET 11T302PEFR-S	-	-	-	-	-	-	-	-	-	●	●	-	0,2	1
11T304PEFR-S	-	-	-	-	-	-	-	-	-	●	●	-	0,4	1
11T305PEFR-S	-	-	-	-	-	-	-	-	-	●	●	-	0,5	1
11T308PEFR-S	-	-	-	-	-	-	-	-	-	●	●	-	0,8	1
11T310PEFR-S	-	-	-	-	-	-	-	-	-	●	●	-	1,0	1
11T312PEFR-S	-	-	-	-	-	-	-	-	-	●	●	-	1,2	1
11T316PEFR-S	-	-	-	-	-	-	-	-	-	●	●	-	1,6	1
11T320PEFR-S	-	-	-	-	-	-	-	-	-	●	●	-	2,0	1
11T324PEFR-S	-	-	-	-	-	-	-	-	-	●	●	-	2,4	1
11T330PEFR-S	-	-	-	-	-	-	-	-	-	●	●	-	3,0	2
11T332PEFR-S	-	-	-	-	-	-	-	-	-	●	●	-	3,2	2

Fig. 1

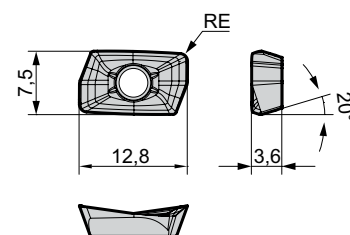
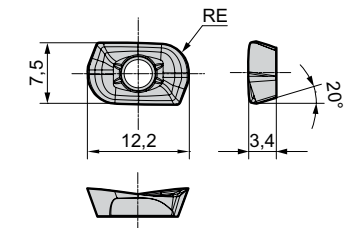

Fig. 2



L: Low cutting force
 G: General purpose
 H: Strong edge
 F: Finishing
 P: High-precision machining
 S: Non ferrous metals

*P16 is applicable to cutter diameters Ø 14 mm and Ø 16 mm.
 *P20 is applicable to cutter diameters Ø 18 mm, Ø 20 mm.
 *P25 is applicable to cutter diameters Ø 25 mm, Ø 28 mm.

Rake Angle	Radial	-6° – -12°	15 mm	90°
	Axial	6° – 15°		



Fig. 1

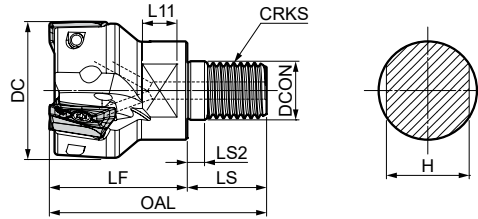

Head

Dimensions (mm)

Cat. No.	Stock	DC	DCON	CRKS	OAL	LF	LS2	L11	H	No. of Teeth	Weight (kg)	Fig.
WEZ 17025M012Z2	●	25	12,5	M12	56	35	5	10	19	2	0,08	1
17025M012Z3	●	25	12,5	M12	56	35	5	10	19	3	0,07	1
17028M012Z2	●	28	12,5	M12	56	35	5	10	19	2	0,10	1
17030M016Z2	●	30	17	M16	63	40	5	10	24	2	0,17	1
17030M016Z3	●	30	17	M16	63	40	5	10	24	3	0,15	1
17032M016Z2	●	32	17	M16	63	40	5	10	24	2	0,19	1
17032M016Z3	●	32	17	M16	63	40	5	10	24	3	0,16	1
17032M016Z4	●	32	17	M16	63	40	5	10	24	4	0,14	1
17035M016Z2	●	35	17	M16	63	40	5	10	24	2	0,21	1
17035M016Z3	●	35	17	M16	63	40	5	10	24	3	0,19	1
17040M016Z2	●	40	17	M16	63	40	5	10	24	2	0,15	1
17040M016Z3	●	40	17	M16	63	40	5	10	24	3	0,23	1
17040M016Z4	●	40	17	M16	63	40	5	10	24	4	0,21	1

Inserts are sold separately. Arbor see P44

Spare Parts

Applicable Cutters	Insert Screw		Wrench
WEZ 17025M12Z2–17030M16Z3 17032M16Z2–17040M16Z4	BFTX0407IP BFTX0409IP	3,0	TRDR15IP

Identification Details

WEZ	17	025	M 12	Z2
Cutter Series	Insert Size	Cutter Diameter	Mounting Screw Size	Number of Teeth

Recommended Cutting Conditions

→ P. 8

*When mounting inserts with nose radius of $\geq 2,4$ mm, modification of the body is required.

Modify this edge.

Reworking guidelines
 Corner radius = 2,4 mm: C = 1 mm (AOMT170524PEER)
 Corner radius = 3,0 mm: C = 1 mm (AOMT170530PEER)
 Corner radius = 3,2 mm: C = 1 mm (AOMT170532PEER)
 Corner radius = 4,0 mm: C = 2 mm (AOMT170540PEER)
 Corner radius = 5,0 mm: C = 5 mm (AOMT170550PEER)
 Corner radius = 6,4 mm: C = 5 mm (AOMT170564PEER)
 Standard: R = 1 mm

C: Chamfer
R: Radius

Inserts

Precautions for Mounting

→ P. 9

Application	Coated Carbide								Carbide	DLC	Cermets	Dimensions (mm)		
	KP	PM	P	K	K	MS	MS	MS						
High Speed / Light Cut														
General Purpose														
Roughing														
Cat. No.	ACU2500	XCU2500	ACP2000	ACP3000	XCK2000	ACK2000	ACK3000	ACM200	ACM300	H20	DL2000	T2500A	RE	Fig.
AOMT 170502PEER-L	●												0,2	1
170504PEER-L	●	○											0,4	1
170508PEER-L	●	○											0,8	1
170512PEER-L	●												1,2	1
170516PEER-L	●												1,6	1
AOMT 170502PEER-G	●												0,2	1
170504PEER-G	●	○											0,4	1
170505PEER-G	●												0,5	1
170508PEER-G	●	○											0,8	1
170510PEER-G	●												1,0	1
170512PEER-G	●												1,2	1
170516PEER-G	●												1,6	1
170520PEER-G	●												2,0	1
170524PEER-G	●												2,4	1
170530PEER-G	●												3,0	1
170532PEER-G	●												3,2	1
170540PEER-G	●												4,0	1
170550PEER-G	●												5,0	2
170564PEER-G	□												6,4	2
AOMT 170504PEER-H	●	○											0,4	1
170508PEER-H	●	○											0,8	1
170512PEER-H	●												1,2	1
170516PEER-H	●												1,6	1
AOET 170502PEER-F	●												0,2	1
170504PEER-F	●												0,4	1
170505PEER-F	●												0,5	1
170508PEER-F	●												0,8	1
170510PEER-F	●												1,0	1
170512PEER-F	●												1,2	1
170516PEER-F	●												1,6	1
170520PEER-F	●												2,0	1
170524PEER-F	●												2,4	1
170530PEER-F	●												3,0	1
170532PEER-F	●												3,2	1
170540PEER-F	●												4,0	1
170550PEER-F	●												5,0	2
170564PEER-F	●												6,4	2
AOET 170502PEER-P25	●												0,2	1
170504PEER-P25	●												0,4	1
170505PEER-P25	●												0,5	1
170508PEER-P25	●												0,8	1
170510PEER-P25	●												1,0	1
170512PEER-P25	●												1,2	1
170502PEER-P32	●												0,2	1
170504PEER-P32	●												0,4	1
170505PEER-P32	●												0,5	1
170508PEER-P32	●												0,8	1
170510PEER-P32	●												1,0	1
170512PEER-P32	●												1,2	1
AOET 170502PEFR-S	-	-	-	-	-	-	-	-	-	●	●	-	0,2	1
170504PEFR-S	-	-	-	-	-	-	-	-	-	●	●	-	0,4	1
170505PEFR-S	-	-	-	-	-	-	-	-	-	●	●	-	0,5	1
170508PEFR-S	-	-	-	-	-	-	-	-	-	●	●	-	0,8	1
170510PEFR-S	-	-	-	-	-	-	-	-	-	●	●	-	1,0	1
170512PEFR-S	-	-	-	-	-	-	-	-	-	●	●	-	1,2	1
170516PEFR-S	-	-	-	-	-	-	-	-	-	●	●	-	1,6	1
170520PEFR-S	-	-	-	-	-	-	-	-	-	●	●	-	2,0	1
170524PEFR-S	-	-	-	-	-	-	-	-	-	●	●	-	2,4	1
170530PEFR-S	-	-	-	-	-	-	-	-	-	●	●	-	3,0	1
170532PEFR-S	-	-	-	-	-	-	-	-	-	●	●	-	3,2	1
170540PEFR-S	-	-	-	-	-	-	-	-	-	●	●	-	4,0	1
170550PEFR-S	-	-	-	-	-	-	-	-	-	●	●	-	5,0	2
170564PEFR-S	-	-	-	-	-	-	-	-	-	●	●	-	6,4	2

Fig. 1

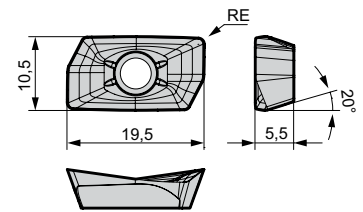
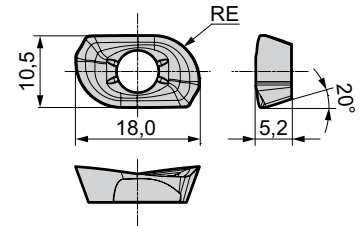

Fig. 2



L: Low cutting force
G: General purpose
H: Strong edge
F: Finishing
P: High-precision machining
S: Non ferrous metals

*P25 is applicable to cutter diameters Ø 25 mm and Ø 28 mm.
*P32 is applicable to cutter diameters Ø 30 mm, Ø 32 mm and Ø 35 mm.

"WaveMill" Series WEZR 11000 M

Repeater, Modular Type

Rake Angle	Radial	-12°	27 mm	90°
	Axial	11°		



Fig. 1

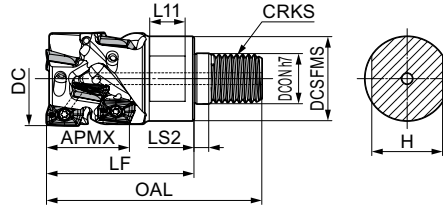

Head

Dimensions (mm)

Cat. No.	Stock	DC	APMX	DCSFMS	DCON	CRKS	OAL	LF	LS2	L11	H	Total No. of Teeth	Steps	Effective No. of Teeth	Weight (kg)	Fig.
WEZR 11032M1627Z3	○	32	27	28,5	17	M16	73	50	5	12	24	9	3	3	0,21	1

Inserts are sold separately. Arbor → P44

Spare Parts

Applicable Cutters	Insert Screw		Wrench
WEZR 11_ _ _	BFTX0306IP	1,5	TRDR08IP

Identification Details

WEZR 11	032	M16	27	Z3
Cutter Series	Insert Size	Cutter Diameter	Mounting Screw Size	Max. Depth of Cut
				Effective Number of Teeth

Recommended Cutting Conditions

ISO	Work Material	Hardness (HB)	Chip breaker	Cutting Speed v_c (m/min)	Feed Rate f_z (mm/t)	Grades
P	Carbon Steel	≤ 280HB	G	100-150-200	0,08-0,12-0,20	ACU2500 XCU2500
		> 280HB	G	80-100-120	0,08-0,12-0,20	ACP2000 ACP3000
	Alloy Steel	≤ 280HB	G	100-150-80	0,08-0,12-0,20	ACP3000
M	Stainless Steel	≤ 280HB	G	80-120-160	0,08-0,12-0,20	ACU2500 ACM200 ACM300
K	Cast Iron Ductile Cast Iron	-	G	100-150-200	0,08-0,12-0,20	ACU2500 XCK2000 ACK2000 ACK3000
S	Exotic Alloy	-	G	40-50-60	0,08-0,12-0,20	ACU2500 ACM200 ACM300
N	Aluminum Alloy	Si ≤ 12,6%	S	300-500-800	0,05-0,10-0,15	DL2000
		Si > 12,6%	S	100-200-250	0,05-0,10-0,15	H20

Min. - Optimum - Max.

Note:

The cutting conditions above are a guide. Actual conditions will need to be adjusted according to machine rigidity, work clamp rigidity, depth of cut and other factors. There may be cases where machining cannot be performed under recommended cutting conditions, depending on the machine rigidity and work rigidity.

*When mounting inserts with nose radius of $\geq 2,4$ mm, modification of the body is required.



Modify this edge.

Reworking guidelines

Corner radius = 2,4 mm: C = 1 mm

(AOMT11T324PEER)

Corner radius = 3,0 mm: C = 1 mm

(AOMT11T330PEER)

Corner radius = 3,2 mm: C = 1 mm

(AOMT11T332PEER)

Standard: R = 1 mm

C: Chamfer

R: Radius

Inserts

Precautions for Mounting → P.9

Application	Coated Carbide								Carbide	DLC	Cermet	Dimensions (mm)		
High Speed / Light Cut														
General Purpose														
Roughing														
Cat. No.	ACU2500	XCU2500	ACP2000	ACP3000	XCK2000	ACK2000	ACK3000	ACM200	ACM300	H20	DL2000	T2500A	RE	Fig.
AOMT 11T302PEER-G	●		□	●		□	●	●	●	-	-	●	0,2	1
11T304PEER-G	●	○	●	●	○	●	●	●	●	-	-	●	0,4	1
11T305PEER-G	●		●	□		□	●	●	●	-	-	●	0,5	1
11T308PEER-G	●	○	●	●	○	●	●	●	●	-	-	●	0,8	1
11T310PEER-G	●		□	□		□	●	●	●	-	-	□	1,0	1
11T312PEER-G	●		□	●		□	●	●	●	-	-	□	1,2	1
11T316PEER-G	●		□	●		□	●	●	●	-	-		1,6	1
11T320PEER-G	●		□	●		□	●	●	●	-	-		2,0	1
11T324PEER-G	●		□	□		□	●	●	●	-	-		2,4	1
11T330PEER-G	●		□	●		□	●	●	●	-	-		3,0	2
11T332PEER-G	●		□	□		□	●	●	●	-	-		3,2	2
AOMT 11T304PEER-H	●	○	●	●	○	●	●	●	●	-	-	-	0,4	1
11T308PEER-H	●	○	●	●	○	●	●	●	●	-	-	-	0,8	1
11T312PEER-H	●		□	□		□	□	●	●	-	-	-	1,2	1
11T316PEER-H	●		□	□		□	□	●	●	-	-	-	1,6	1
AOET 11T302PEER-F	●		-			-				-	-	-	0,2	1
11T304PEER-F	●		-			-				-	-	-	0,4	1
11T305PEER-F	●		-			-				-	-	-	0,5	1
11T308PEER-F	●		-			-				-	-	-	0,8	1
11T310PEER-F	●		-			-				-	-	-	1,0	1
11T312PEER-F	●		-			-				-	-	-	1,2	1
11T316PEER-F	●		-			-				-	-	-	1,6	1
11T320PEER-F	●		-			-				-	-	-	2,0	1
11T324PEER-F	●		-			-				-	-	-	2,4	1
11T330PEER-F	●		-			-				-	-	-	3,0	2
11T332PEER-F	●		-			-				-	-	-	3,2	2
AOET 11T302PEFR-S	-	-	-	-	-	-	-	-	●	●	-	-	0,2	1
11T304PEFR-S	-	-	-	-	-	-	-	-	●	●	-	-	0,4	1
11T305PEFR-S	-	-	-	-	-	-	-	-	●	●	-	-	0,5	1
11T308PEFR-S	-	-	-	-	-	-	-	-	●	●	-	-	0,8	1
11T310PEFR-S	-	-	-	-	-	-	-	-	●	●	-	-	1,0	1
11T312PEFR-S	-	-	-	-	-	-	-	-	●	●	-	-	1,2	1
11T316PEFR-S	-	-	-	-	-	-	-	-	●	●	-	-	1,6	1
11T320PEFR-S	-	-	-	-	-	-	-	-	●	●	-	-	2,0	1
11T324PEFR-S	-	-	-	-	-	-	-	-	●	●	-	-	2,4	1
11T330PEFR-S	-	-	-	-	-	-	-	-	●	●	-	-	3,0	2
11T332PEFR-S	-	-	-	-	-	-	-	-	●	●	-	-	3,2	2

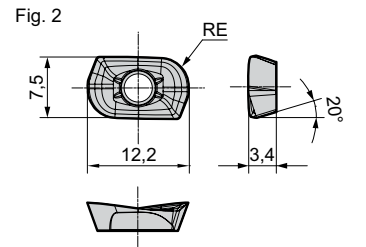
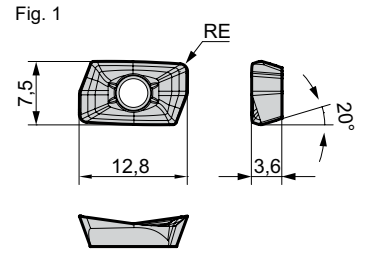

L: Low cutting force
 G: General purpose
 H: Strong edge
 F: Finishing
 P: High-precision machining
 S: Non ferrous metals

Use peripheral inserts with RE ≤ 0,8 mm from the second step and above.

"WaveMill" Series WEZR 17000 M

Repeater, Modular Type

Rake Angle	Radial	-9°	29 mm	90°
	Axial	10°		



Fig. 1

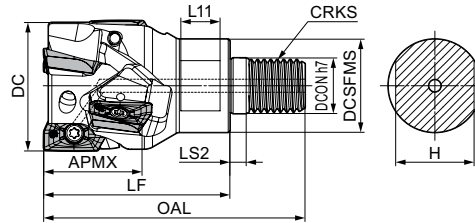



Head

Dimensions (mm)

Cat. No.	Stock	DC	APMX	DCSFMS	DCON	CRKS	OAL	LF	LS2	L11	H	Total No. of Teeth	Steps	Effective No. of Teeth	Weight (kg)	Fig.
WEZR 17040M1629Z3	○	40	29	28,5	17	M16	80	57	5	12	24	6	2	3	0,29	1

Inserts are sold separately. Arbor → P44

Spare Parts

Applicable Cutters	Insert Screw		Wrench
			
WEZR 17_ _ _	BFTX0409IP	3,0	TRDR15IP

Identification Details

WEZR 17 040 M16 29 Z3

Cutter Series	Insert Size	Cutter Diameter	Mounting Screw Size	Max. Depth of Cut	Effective Number of Teeth
---------------	-------------	-----------------	---------------------	-------------------	---------------------------

Recommended Cutting Conditions

ISO	Work Material	Hardness (HB)	Chip Breaker	Cutting Speed v_c (m/min)	Feed Rate f_z (mm/t)	Grades
P	Carbon Steel	≤ 280HB	G	100-150-200	0,10-0,20-0,30	ACU2500 XCU2500 ACP2000 ACP3000
		> 280HB	G	80-100-120	0,10-0,20-0,30	
	Alloy Steel	≤ 280HB	G	100-150-80	0,10-0,20-0,30	
M	Stainless Steel	≤ 280HB	G	80-120-160	0,10-0,20-0,30	ACU2500 ACM200 ACM300
K	Cast Iron Ductile Cast Iron	-	G	100-150-200	0,10-0,20-0,30	ACU2500 XCK2000 ACK2000 ACK3000
S	Exotic Alloy	-	G	40-50-60	0,10-0,20-0,30	ACU2500 ACM200 ACM300
N	Aluminum Alloy	Si ≤ 12,6%	S	300-500-800	0,05-0,10-0,15	DL2000 H20
		Si > 12,6%	S	100-200-250	0,05-0,10-0,15	

Min. - Optimum - Max.

Note:

The cutting conditions above are a guide. Actual conditions will need to be adjusted according to machine rigidity, work clamp rigidity, depth of cut and other factors. There may be cases where machining cannot be performed under recommended cutting conditions, depending on the machine rigidity and work rigidity.

*When mounting inserts with nose radius of $\geq 2,4$ mm, modification of the body is required.



Modify this edge.

Reworking guidelines

Corner radius = 2,4 mm: C = 1 mm (AOMT170524PEER)

Corner radius = 3,0 mm: C = 1 mm (AOMT170530PEER)

Corner radius = 3,2 mm: C = 1 mm (AOMT170532PEER)

Corner radius = 4,0 mm: C = 2 mm (AOMT170540PEER)

Corner radius = 5,0 mm: C = 5 mm (AOMT170550PEER)

Corner radius = 6,4 mm: C = 5 mm (AOMT170564PEER)

Standard: R = 1 mm

C: Chamfer
R: Radius

Inserts

Precautions for Mounting → P.9

Application	Coated Carbide								Carbide	DLC	Cermets	Dimensions (mm)		
High Speed / Light Cut														
General Purpose														
Roughing														
Cat. No.	ACU2500	XCU2500	ACP2000	ACP3000	XCK2000	ACK2000	ACK3000	ACM200	ACM300	H20	DL2000	T2500A	RE	Fig.
AOMT 170502PEER-L	●			□			□	●	●			□	0,2	1
170504PEER-L	●	○			○			●	●				0,4	1
170508PEER-L	●	○		●	○		●	●	●			●	0,8	1
170512PEER-L	●			□			□	●	●				1,2	1
170516PEER-L	●			□			□	●	●				1,6	1
AOMT 170502PEER-G	●		□	●		□	●	●	●			□	0,2	1
170504PEER-G	●	○	●	●	○	●	●	●	●			●	0,4	1
170505PEER-G	●		□	□		□	□	●	●				0,5	1
170508PEER-G	●	○	●	●	○	●	●	●	●			●	0,8	1
170510PEER-G	●		□	□		□	□	●	●			□	1,0	1
170512PEER-G	●		□	●		□	●	●	●			□	1,2	1
170516PEER-G	●		□	●		□	●	●	●				1,6	1
170520PEER-G	●		□	●		□	□	●	●				2,0	1
170524PEER-G	●		□	□		□	□	●	●				2,4	1
170530PEER-G	●		□	●		□	●	●	●				3,0	1
170532PEER-G	●		□	□		□	●	●	●				3,2	1
170540PEER-G	●		□	●		□	●	●	●				4,0	1
170550PEER-G	●		□	●		□	□	●	●				5,0	2
170564PEER-G	□		□	□		□	□	●	●				6,4	2
AOMT 170504PEER-H	●	○	●	●	○	●	●	●	●				0,4	1
170508PEER-H	●	○	●	●	○	●	●	●	●				0,8	1
170512PEER-H	●		□	□		□	□	●	●				1,2	1
170516PEER-H	●		□	●		□	□	●	●				1,6	1
AOET 170502PEER-F	●												0,2	1
170504PEER-F	●												0,4	1
170505PEER-F	●												0,5	1
170508PEER-F	●												0,8	1
170510PEER-F	●												1,0	1
170512PEER-F	●												1,2	1
170516PEER-F	●												1,6	1
170520PEER-F	●												2,0	1
170524PEER-F	●												2,4	1
170530PEER-F	●												3,0	1
170532PEER-F	●												3,2	1
170540PEER-F	●												4,0	1
170550PEER-F	●												5,0	2
170564PEER-F	●												6,4	2
AOET 170502PEFR-S	-	-	-	-	-	-	-	-	●	●			0,2	1
170504PEFR-S	-	-	-	-	-	-	-	-	●	●			0,4	1
170505PEFR-S	-	-	-	-	-	-	-	-	●	●			0,5	1
170508PEFR-S	-	-	-	-	-	-	-	-	●	●			0,8	1
170510PEFR-S	-	-	-	-	-	-	-	-	●	●			1,0	1
170512PEFR-S	-	-	-	-	-	-	-	-	●	●			1,2	1
170516PEFR-S	-	-	-	-	-	-	-	-	●	●			1,6	1
170520PEFR-S	-	-	-	-	-	-	-	-	●	●			2,0	1
170524PEFR-S	-	-	-	-	-	-	-	-	●	●			2,4	1
170530PEFR-S	-	-	-	-	-	-	-	-	●	●			3,0	1
170532PEFR-S	-	-	-	-	-	-	-	-	●	●			3,2	1
170540PEFR-S	-	-	-	-	-	-	-	-	●	●			4,0	1
170550PEFR-S	-	-	-	-	-	-	-	-	●	●			5,0	2
170564PEFR-S	-	-	-	-	-	-	-	-	●	●			6,4	2

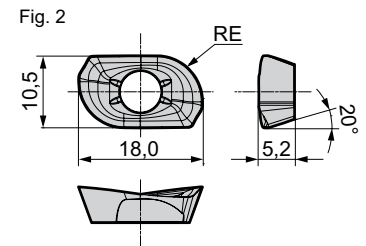
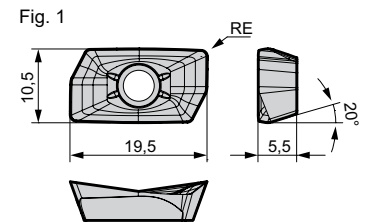

L: Low cutting force
G: General purpose
H: Strong edge
F: Finishing
P: High-precision machining
S: Non ferrous metals

Use peripheral inserts with RE ≤ 0,8 mm from the second step and above.

"WaveMill" Series Modular Tools

■ BBT Integrated Type - Modular Tools Special Arbors

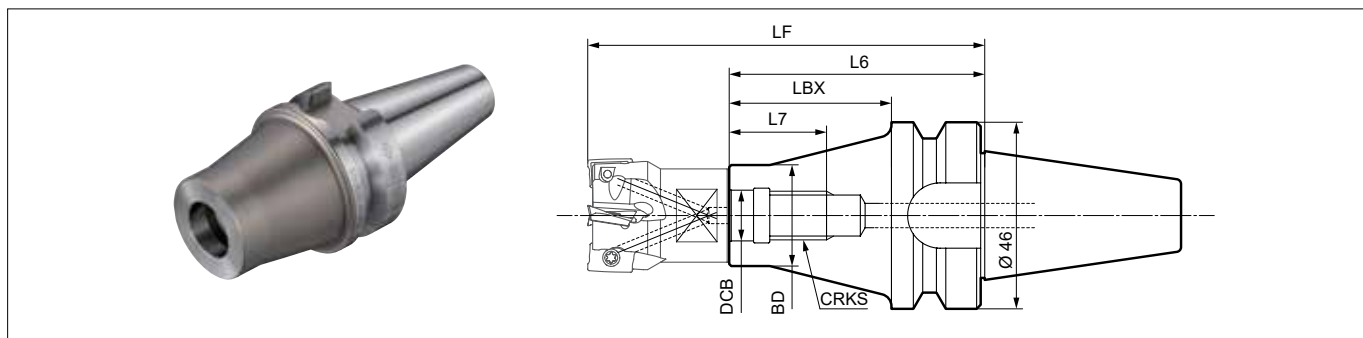

■ BBT Integrated Arbor

Dimensions (mm)

Cat. No.	Stock	CRKS	DCB	BD	L6	LBX	L7	LF*	Coolant Hole
BBT30- M8-50	○	M8	8,5	15,9	73	50	18	98	Yes
M10-45	○	M10	10,5	19,9	68	45	20	98	Yes
M12-40	○	M12	12,5	24,9	63	40	22	98	Yes
M16-35	○	M16	17	31,9	58	35	24	98	Yes

* Overhang length for LF is with head mounted. Can also be used with BT30 special machines.

■ Carbide and Steel Arbor

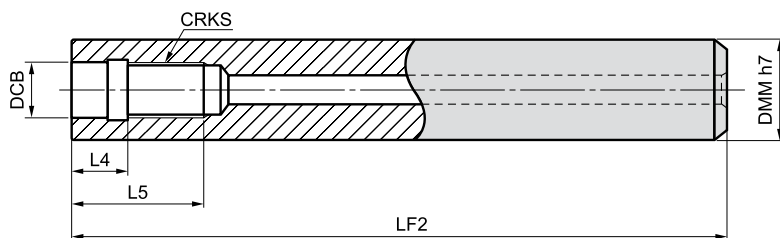
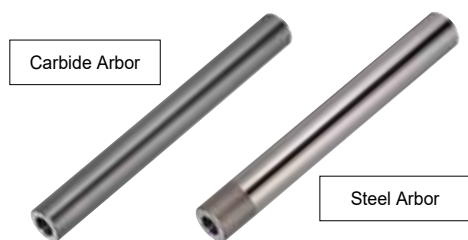

■ Carbide Arbor

Dimensions (mm)

Cat. No.	Stock	CRKS	DCB	DMM	LF2	L4	L5	LF*
MA 15 M08 L120C	●	M8	8,5	15	120	10	18	145
15 M08 L160C	●	M8	8,5	15	160	10	18	185
MA 16 M08 L120C	●	M8	8,5	16	120	10	18	145
16 M08 L160C	●	M8	8,5	16	160	10	18	185
MA 18 M10 L150C	●	M10	10,5	18	150	10	20	180
18 M10 L200C	●	M10	10,5	18	200	10	20	230
MA 20 M10 L150C	○	M10	10,5	20	150	10	20	180
20 M10 L200C	○	M10	10,5	20	200	10	20	230
MA 23 M12 L200C	●	M12	12,5	23	200	10	22	235
23 M12 L250C	●	M12	12,5	23	250	10	22	285
MA 25 M12 L200C	●	M12	12,5	25	200	10	22	235
25 M12 L250C	●	M12	12,5	25	250	10	22	285
MA 28 M16 L200C	●	M16	17,0	28	200	10	24	240
28 M16 L300C	●	M16	17,0	28	300	10	24	340
MA 32 M16 L200C	●	M16	17,0	32	200	10	24	240
32 M16 L300C	●	M16	17,0	32	300	10	24	340

■ Steel Arbor

Dimensions (mm)

Cat. No.	Stock	CRKS	DCB	DMM	LF2	L4	L5	LF*
MA 16 M08 L120S	●	M8	8,5	16	120	10	18	145
MA 20 M10 L150S	●	M10	10,5	20	150	10	20	180
MA 25 M12 L200S	●	M12	12,5	25	200	10	22	235
MA 32 M16 L200S	●	M16	17,0	32	200	10	24	240

■ Identification Details

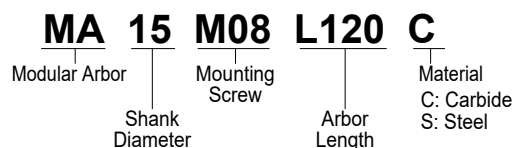

● Modular Tool System

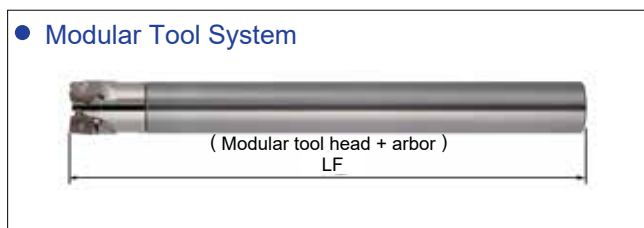

■ Recommended Tightening Torque

Screw	Wrench		Nm
	W	S	
M 8	8	13	23
M10	8	15	46
M12	10	19	60
M16	10,12	24	80





Notes about tightening the head:

When mounting the head to an arbor, follow the attached tightening torque in the table above.

Check the mounting screw diameter for the head and arbor beforehand.

Application Examples

C40, Hub		P	Sumitomo	Competitor
Vertical Machining Centre BT40 	Tool		WEZ17025E02	4 corners per side
	Grade		ACU2500	–
	Chipbreaker		G	–
	Cutter Diam. (mm)		25	25
	Number of Teeth		2	2
	v_c (m/min)		120	120
	v_f (mm/min)		300	300
	f_z (mm/t)		0,066	0,066
	a_p (mm)		9	9
	a_e (mm)		5	5
	Coolant		Wet	Wet
	Results	The high chattering sound typical of thin workpieces is gone and stable machining enables longer tool life.		

C50, Mould Parts		P	Sumitomo	Competitor
Ram type milling machine BT40 	Tool		WEZ11022E03	2 corners per side
	Grade		T2500A	–
	Chipbreaker		G	–
	Cutter Diam. (mm)		22	22
	Number of Teeth		3	3
	v_c (m/min)		83	75
	v_f (mm/min)		320	290
	f_z (mm/t)		0,09	0,09
	a_p (mm)		2,5	2,5
	a_e (mm)		10	10
	Coolant		–	–
	Results	Cermet grades improve surface quality and machining efficiency		

SM490A, Machine Component		P	Sumitomo	Competitor
Vertical Machining Centre BT50 	Tool		WEZ17032EL03	2 corners per side
	Grade		ACU2500	–
	Chipbreaker		G	–
	Cutter Diam. (mm)		32	32
	Number of Teeth		3	2
	v_c (m/min)		150	150
	v_f (mm/min)		671	447
	f_z (mm/t)		0,15	0,15
	a_p (mm)		1,25	1,25
	a_e (mm)		32	32
	Coolant		Wet	Wet
	Results	Efficiency improved 1,5x, quiet and stable machining.		

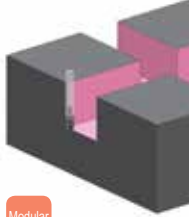
C50, Machine Component		P	Sumitomo	Competitor
5-axis Control Vertical Machining Centre HSK-A100 	Tool		WEZ11020M10Z3	2 corners per side
	Grade		ACU2500	–
	Chipbreaker		G	–
	Cutter Diam. (mm)		20	20
	Number of Teeth		3	3
	v_c (m/min)		72	72
	v_f (mm/min)		4.000	4.000
	f_z (mm/t)		0,2	0,2
	a_p (mm)		0,7	0,7
	a_e (mm)		20	20
	Coolant		Dry	Dry
	Results	Stability without chatter even in groove milling with overhang of 120 mm (L/D=6)		

X2CrNiMo17132, Machine Component		M	Sumitomo	Competitor
Vertical Machining Centre BT40 	Tool		WEZ17035E03	–
	Grade		ACU2500	–
	Chipbreaker		P	–
	Cutter Diam. (mm)		35	–
	Number of Teeth		3	–
	v_c (m/min)		100	–
	v_f (mm/min)		410	–
	f_z (mm/t)		0,15	–
	a_p (mm)		9	–
	a_e (mm)		0,1	–
	Coolant		Wet	–
	Results	Excellent surface accuracy, applicable to finishing operations ($a_e = 0,1$ mm).		

SCS13, Machine Component		M	Sumitomo	Competitor
Vertical Machining Centre BT50 	Tool		WEZ11040E04	4 corners per side
	Grade		ACM300	–
	Chipbreaker		G	–
	Cutter Diam. (mm)		40	40
	Number of Teeth		4	4
	v_c (m/min)		80	80
	v_f (mm/min)		254	254
	f_z (mm/t)		0,1	0,1
	a_p (mm)		1	1
	a_e (mm)		40	40
	Coolant		–	–
	Results	Longer tool life without chipping even when machining the black scale layer.		

Application Examples

X5CrNiS18 10, Semiconductor Device M		Sumitomo	Competitor
Horizontal Machining Centre BT50 	Tool	WEZ17050RS05	double sided, 4 corners
	Grade	ACU2500	–
	Chipbreaker	G	–
	Cutter Diam. (mm)	50	50
	Number of Teeth	5	5
	v_c (m/min)	80	80
	v_f (mm/min)	320	320
	f_z (mm/t)	0,13	0,13
	a_p (mm)	0,2	0,2
	a_e (mm)	40	40
	Coolant	Wet	Wet
	Results	Improved surface finish quality and reduced burrs, cutting post-processing time by 50%	

Stainless Steel Duplex SUS Machine Component M		Sumitomo	Competitor
Multi-tasking Machine 	Tool	WEZ11025ES02-16*	2 corners per side
	Grade	ACU2500	–
	Chipbreaker	F	–
	Cutter Diam. (mm)	25	25
	Number of Teeth	2	2
	v_c (m/min)	90	90
	v_f (mm/min)	300	300
	f_z (mm/t)	0,13	0,13
	a_p (mm)	1,5	1,5
	a_e (mm)	25	25
	Coolant	Wet	Wet
	Results	Suppresses burrs and extends tool life by 1,6x.	

* Made to order product

GG-30, Machine Component K		Sumitomo	Competitor
Vertical Machining Centre BT50 	Tool	WEZ17063RS06	2 corners per side
	Grade	ACK3000	–
	Chipbreaker	G	–
	Cutter Diam. (mm)	63	63
	Number of Teeth	6	4
	v_c (m/min)	150	175
	v_f (mm/min)	377	254
	f_z (mm/t)	0,08	0,07
	a_p (mm)	3,5	3,5
	a_e (mm)	50	50
	Coolant	Wet	Wet
	Results	Helical machining with 1,5 times higher efficiency and two times longer tool life	

GG-25, Machine Component K		Sumitomo	Competitor
Horizontal Machining Centre BT50 	Tool	WEZ11050RS07	2 corners per side
	Grade	ACU2500	–
	Chipbreaker	G	–
	Cutter Diam. (mm)	50	50
	Number of Teeth	7	5
	v_c (m/min)	180	180
	v_f (mm/min)	805	574
	f_z (mm/t)	0,1	0,1
	a_p (mm)	0,3	0,3
	a_e (mm)	10	10
	Coolant	Wet	Wet
	Results	Quiet machining noise and improved machining efficiency Excellent flatness and surface finish with 3 μ m parallelism and 4 μ m flatness.	

GG-25, Crank Shaft K		Sumitomo	Competitor
	Tool	WEZ17050E05	–
	Grade	XCK2000	–
	Chipbreaker	G	–
	Cutter Diam. (mm)	50	50
	Number of Teeth	5	5
	v_c (m/min)	188	188
	v_f (mm/min)	898	898
	f_z (mm/t)	0,15	0,15
	a_p (mm)	1,0	1,0
	a_e (mm)	–	–
	Coolant	Wet	Wet
	Results	Excellent wear resistance, achieves 4,7 times longer tool life.	

GG-25, Railway Component K		Sumitomo	Competitor
Vertical Machining Centre 	Tool	WEZ11040M16Z6	4 corners per side
	Grade	ACK3000	–
	Chipbreaker	G	–
	Cutter Diam. (mm)	40	40
	Number of Teeth	6	3
	v_c (m/min)	37	48
	v_f (mm/min)	707	344
	f_z (mm/t)	0,4	0,3
	a_p (mm)	2,5x1 pass+1	1,5x2 passes+0,5
	a_e (mm)	–	–
	Coolant	Wet	Wet
	Results	Increased cutting edge sharpness enables stable machining with efficiency improved 4,5x.	

Application Examples

Plastics Electronics		N	Sumitomo	Competitor
Vertical Machining Centre BT40 	Tool		WEZ11080R07	2 corners per side
	Grade		DL2000	–
	Chipbreaker		S	–
	Cutter Diam. (mm)		80	80
	Number of Teeth		7	7
	v_c (m/min)		376	376
	v_f (mm/min)		1.050	1.050
	f_z (mm/t)		0,1	0,1
	a_p (mm)		3	3
	a_e (mm)		50	50
	Coolant		Wet	Wet
	Results		Lower noise level due to improved cutting performance.	

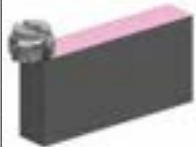
Al-Alloy A2025, Machine Component		N	Sumitomo	Competitor
Ram type milling machine BT40 	Tool		WEZ17063RS04	2 corners per side
	Grade		H20	–
	Chipbreaker		S	–
	Cutter Diam. (mm)		63	63
	Number of Teeth		4	4
	v_c (m/min)		1.187	1.187
	v_f (mm/min)		1.920	1.920
	f_z (mm/t)		0,08	0,08
	a_p (mm)		1	1
	a_e (mm)		50	50
	Coolant		–	–
	Results		Very little dimensional fluctuation and machining precision is stable.	

FRPP Resin Industrial Machine Component		N	Sumitomo	Competitor
Horizontal Machining Centre BT50 	Tool		WEZ11020E02	2 corners per side
	Grade		ACM300	–
	Chipbreaker		L	–
	Cutter Diam. (mm)		20	20
	Number of Teeth		2	3
	v_c (m/min)		200	37
	v_f (mm/min)		640	220
	f_z (mm/t)		0,1	0,091
	a_p (mm)		5-9 x 3 passes	5-9 x 3 passes
	a_e (mm)		0,95 x 1 pass	0,95 x 1 pass
	Coolant		–	–
	Results		Minimized wall surface step, increasing machining efficiency.	

Al-Alloy A5052 Machine Component		N	Sumitomo	–
5-axis Control Vertical Machining Centre HSK-A100 	Tool		WEZ17025M12Z2	–
	Grade		DL2000	–
	Chipbreaker		S	–
	Cutter Diam. (mm)		25	–
	Number of Teeth		2	–
	v_c (m/min)		785	–
	v_f (mm/min)		4.000	–
	f_z (mm/t)		0,2	–
	a_p (mm)		3,9	–
	a_e (mm)		25	–
	Coolant		Wet	–
	Results		Stable machining without chatter even at overhang of 100 mm (L/D=4)	

Titanium Alloys, Aircraft Component		S	Sumitomo	Competitor
Combined Lathe 	Tool		WEZ17035E03	2 corners per side
	Grade		ACM300	–
	Chipbreaker		L	–
	Cutter Diam. (mm)		35	35
	Number of Teeth		3	3
	v_c (m/min)		45	45
	v_f (mm/min)		–	–
	f_z (mm/t)		0,16	0,16
	a_p (mm)		3	3
	a_e (mm)		17,5	17,5
	Coolant		Wet	Wet
	Results		Tool life improvement.	



Titanium Alloy Ti-6Al-4V Aerospace Component		S	Sumitomo	Competitor
Vertical Machining Centre BT50 	Tool		WEZ11063RS08	2 corners per side
	Grade		ACU2500	–
	Chipbreaker		G	–
	Cutter Diam. (mm)		63	63
	Number of Teeth		8	8
	v_c (m/min)		48	48
	v_f (mm/min)		310	310
	f_z (mm/t)		0,16	0,16
	a_p (mm)		2	2
	a_e (mm)		50	50
	Coolant		Wet	Wet
	Results		No chipping, longer tool life with reduced burrs.	

Application Examples WEZR Type

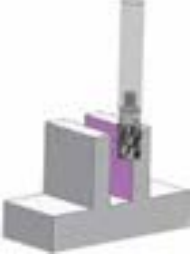
SUM42L, Machine Component		P	Sumitomo	Competitor
	Tool		WEZR11032E3632Z003	2 corners per side
	Grade		ACU2500	–
	Chipbreaker		G	–
	Cutter Diam. (mm)		32	25
	Number of Teeth		3x4 stages	2x3 stages
	v_c (m/min)		120	80
	v_f (mm/min)		716	102
	f_z (mm/t)		0,20	0,05
	a_p (mm)		32	32
	a_e (mm)		3,0	0,8
	Coolant		Wet	Wet
	Results	No chatter, Efficiency increased 12x or more.		

GG-25, Automotive Component		K	Sumitomo	Competitor
	Tool		WEZR11032M1645Z3*	2 corners per side
	Grade		ACU2500	–
	Chipbreaker		G	–
	Cutter Diam. (mm)		32	25
	Number of Teeth		3x5 stages	3x5 stages
	v_c (m/min)		80	80
	v_f (mm/min)		500	500
	f_z (mm/t)		0,2	0,2
	a_p (mm)		45	45
	a_e (mm)		0,5–6,0	0,5–6,0
	Coolant		Dry	Dry
	Results	Capable of low-chatter machining even at a tool overhang amount of 200 mm.		

* Made to order product

Titanium Alloy Ti-6Al-4V Aerospace Component		S	Sumitomo	Competitor
 	Tool		WEZR11032M1618Z3*	2 corners per side
	Grade		ACM300	–
	Chipbreaker		G	–
	Cutter Diam. (mm)		32	32
	Number of Teeth		3x2 stages	3x3 stages
	v_c (m/min)		40	40
	v_f (mm/min)		119	84
	f_z (mm/t)		0,10	0,07
	a_p (mm)		15	15
	a_e (mm)		24	24
	Coolant		Wet	Wet
	Results	Capable of machining at reduced cutting force, even at 14 times the feed rate.		

* Made to order product

Al-Alloy ADC12, Aerospace Component		N	Sumitomo	Competitor
	Tool		WEZR11033E4525Z03*	Solid Endmill
	Grade		DL2000	–
	Chipbreaker		G	–
	Cutter Diam. (mm)		33	32
	Number of Teeth		3x5 stages	4
	v_c (m/min)		487	100
	v_f (mm/min)		800	224
	f_z (mm/t)		0,056	0,056
	a_p (mm)		25	25
	a_e (mm)		1	1
	Coolant		Wet	Wet
	Results	Efficiency increased 5x or more, for reduced tool costs.		

* Made to order product



(Germany)
SUMITOMO ELECTRIC Hartmetall GmbH
Konrad-Zuse-Straße 9, 47877 Willich



Tel. +49 2154 4992-0, Fax +49 2154 4992-161
Info@SumitomoTool.com
www.SumitomoTool.com

(UK and Ireland)
SUMITOMO ELECTRIC Hardmetal Ltd.
3 Paper Mill Drive
Redditch, B98 8QJ, UK



Tel. +44 1844 342081, Fax: +44 1844 342415
InfoUK@SumitomoTool.com
www.SumitomoTool.com

Distributed by: